



## Diesel Replacement parts 05/2016

Diesel Ersatzteile

Pièces diesel

Piezas diesel

Diesel Parti

Дизель Запчасти





# Diesel Replacement parts

## 05/2016

Diesel Ersatzteile, Pièces diesel, Piezas diesel, Diesel Parti, Дизель Запчасти

|   |   |    |
|---|---|----|
|    | <b>About Us</b><br>Über uns<br>A propos de nous<br>Acerca de nosotros<br>Chi siamo<br>О нас   | 2  |
|    | <b>Product Overview</b><br>Produktübersicht<br>Présentation du produit<br>Descripción del producto<br>Panoramica prodotti<br>Обзор Продукта                           | 3  |
|  | <b>Product Information</b><br>Produktinformationen<br>Information produit<br>Información del producto<br>Informazioni sul prodotto<br>Информация О Продукте           | 6  |
|  | <b>Manufacturer Index</b><br>Herstellerverzeichnis<br>Les fabricants<br>Directorio de fabricantes<br>Elenco produttori<br>Производители Каталог                       | 19 |
|  | <b>Product Application</b><br>Produktverwendungen<br>Utilisations du produit<br>Aplicaciones el producto<br>Usi del prodotto<br>использование продукта                | 22 |
|  | <b>Cross-Reference List</b><br>Referenzliste<br>Liste de référence<br>Lista de referencia<br>Lista di referenze<br>Список Литературы                                  | 61 |
|  | <b>Symbols and Abbreviations</b><br>Symbole und Abkürzungen<br>Symboles et abréviations<br>Símbolos y abreviaturas<br>Simboli e abbreviazioni<br>Символы и сокращения | 73 |



## Focused on the future

Working with us, you can look forward to good business. With our wide range of leading-edge products and comprehensive distribution network, we are perfectly set up to meet current and future demands. And we're always interested in hearing our partners' ideas and suggestions.

Our innovative capacity and quality as an original equipment manufacturer are available to you in each product in the replacement parts range – for vehicle diagnostics, fuel systems, engine actuators and sensors. It's your guarantee of lasting success in the automotive world of tomorrow.

## Das Unternehmen Zukunft

Die Chancen für gemeinsame erfolgreiche Geschäfte stehen gut. Denn mit unserem zukunftsorientierten Produktspektrum und unserem flächendeckenden Vertriebsnetz sind wir für aktuelle wie für kommende Aufgaben erstklassig aufgestellt. Dabei sind für uns die Wünsche und Anregungen unserer Partner jederzeit von großer Bedeutung.

Mit jedem unserer Produkte im Kfz-Ersatzteilebereich – von der Fahrzeugdiagnose über Kraftstoffsysteme und Motorstullelemente bis hin zu Sensoren – stehen Ihnen die Innovationskraft und Qualität des Erstausrüsters zur Verfügung. Serienmäßig, als langfristige Erfolgsgaranten in der automotiven Welt von morgen.

## L'entreprise du futur

Les chances de réaliser ensemble des affaires fructueuses sont bonnes. En effet, avec notre gamme de produits porteuse d'avenir et notre vaste réseau de distribution, nous sommes parfaitement à même d'accomplir les tâches du présent et de l'avenir, d'autant plus que les souhaits et les suggestions de nos partenaires revêtent toujours une grande importance pour nous.

Avec chacun de nos produits du secteur des pièces de rechange pour véhicules – du diagnostic automobile aux capteurs en passant par les circuits de carburant et les éléments de réglage du moteur – vous bénéficiez de la force d'innovation et de la qualité de l'équipementier de première monte. Ces produits de série sont des garants durables du succès dans le monde automobile de demain.

## La empresa futura

Se presentan buenas oportunidades para realizar negocios conjuntos colmados de éxito, ya que, con nuestra gama de productos orientada al futuro y nuestra red de distribución de cobertura global, somos los líderes a la hora de llevar a cabo las tareas actuales y venideras. Además, para nosotros, los deseos y las sugerencias de nuestros socios tienen siempre la máxima relevancia.

Con cada uno de nuestros productos del sector de piezas de recambio para el automóvil – desde el diagnóstico del vehículo hasta los sensores, pasando por los sistemas de combustible y los elementos de ajuste del motor –, usted dispone de la fuerza innovadora y la calidad del proveedor de equipo original. De serie, para garantizarle el éxito a largo plazo en el mundo de la automoción del mañana.

## Il futuro dell'azienda

Vi sono ottime opportunità di successo per la nostra e vostra attività commerciale. Con la nostra gamma di prodotti di avanzata tecnologia e la nostra ampia rete di distribuzione siamo perfettamente posizionati sia rispetto al presente che al futuro. I suggerimenti e le esigenze dei nostri partners sono per noi sempre di grande importanza.

Tutti i nostri prodotti del settore automotive, dagli apparecchi diagnostici ai sistemi di alimentazione, dagli attuatori motore ai sensori, sono realizzati in modo innovativo e con la elevata qualità propria di una azienda produttrice di sistemi destinati al primo equipaggiamento. Garanzia di successo immediato ed a lungo termine per il settore automobilistico di oggi e di domani.

## Предприятие - будущее

Шансы успешного совместного бизнеса - очень хорошие. Потому что с нашим спектром продукции, ориентированным на будущее, и с нашей широкой сетью сбыта мы великолепно подготовлены к решению текущих и будущих задач. При этом пожелания и инициативы наших партнеров имеют для нас всегда огромное значение.

В каждом из наших продуктов в области автомобилестроения – от диагностики автомобилей, топливных систем и элементов настройки двигателей до датчиков – в Вашем распоряжении находится инновационная сила и качество предприятия-изготовителя. Серийно, в качестве долгосрочного гаранта успеха в автомобильном мире завтрашнего дня.



## Product Overview

Produktübersicht

Présentation du produit

Descripción del producto

Panoramica prodotti

Обзор Продукта



## Diesel common rail piezo injector

Our piezo servo injectors ensure extremely precise injection and ultra-fine atomisation of diesel fuel for highly efficient combustion. Direct-drive piezo injectors make it possible to achieve greater fuel efficiency in powerful engines.

## Diesel Common Rail Piezo Injektor

Unsere Piezo Servo Injektoren sorgen durch äußerst präzise Einspritzung und feinste Zerstäubung des Dieselkraftstoffs für eine hohe Effizienz in der Verbrennung. Mit den direktangetriebenen Piezo Injektoren können bei leistungsstarken Motoren zusätzliche Potenziale hinsichtlich der effizienten Kraftstoffverbrennung ausgeschöpft werden.

## Injecteur piézoélectriques diesel common rail

Nos servo-injecteurs piézoélectriques garantissent une efficacité élevée dans la combustion grâce à une injection extrêmement précise et à une pulvérisation très fine du carburant diesel. Avec les injecteurs piézoélectriques à commande directe, des potentiels supplémentaires en matière d'efficacité de combustion du carburant peuvent être exploités sur les moteurs de forte puissance.

## Inyectore diésel piezo para sistemas Common Rail

Nuestros servoinyectores piezo contribuyen a una elevada eficiencia en la combustión gracias a su inyección extremadamente precisa y la atomización finísima del combustible diésel. Con los inyectoros piezo de accionamiento directo pueden aprovecharse nuevos potenciales en cuanto a la combustión eficiente del carburante en los motores de gran potencia.

## Iniettor diesel common rail piezoelettrici

I nostri iniettori piezoelettrici garantiscono una iniezione di alta precisione ed una fine atomizzazione del carburante diesel per una elevata efficienza della combustione. Con l'azionamento diretto dell'attuatore piezoelettrico dell'inietttore, tutte le condizioni di funzionamento dei moderni potenti motori sono soddisfatte.

## Форсунки Piezo для систем впрыска с общим нагнетательным трубопроводом типа Common Rail

Наши форсунки с пьезоуправлением благодаря чрезвычайно прецизионному впрыскиванию и мельчайшему распылению дизельного топлива обеспечивают высокую эффективность сгорания. С помощью форсунок Piezo прямого действия можно в мощных двигателях использовать дополнительный потенциал в отношении эффективного сгорания топлива.



## Diesel common rail pump

Our high-pressure diesel pumps have been specially developed for the latest generation of common rail diesel injection systems. They enable a compact design and low weight, and are dimensioned for pressures up to 2,500 bar.

Continental's diesel piezo common rail systems offer the following advantages:

- Compliance with current and future emission limits.
- Reduced CO<sub>2</sub> emissions
- Increased performance, with lower fuel consumption and quiet operation

## Diesel Common Rail Pumpe

Unsere Diesel Hochdruckpumpen wurden speziell für die neueste Generation der Diesel Common Rail Einspritzsysteme entwickelt. Ihr Konzept ermöglicht eine kompakte Bauweise und ein geringes Gewicht. Die Auslegung unterstützt Drücke bis zu 2.500 bar.

Damit bieten Continentals Diesel Piezo-Common Rail Systeme folgende Vorteile:

- Einhaltung aktueller und künftiger Abgasgrenzwerte
- Senkung des CO<sub>2</sub>-Ausstoßes
- Gesteigerte Leistung bei reduziertem Verbrauch und optimierter Laufruhe



## Pompe diesel common rail

Nos pompes haute pression diesel common rail ont été spécialement développées pour la toute dernière génération de systèmes d'injection diesel common rail. Leur conception permet une construction compacte et un faible poids. Leur dimensionnement supporte des pressions jusqu'à 2 500 bars. Ainsi, les systèmes diesel Piézo-Common Rail de Continental offrent les avantages suivants :

- Respect des valeurs limites actuelles et futures pour les gaz d'échappement.
- Réduction des émissions de CO<sub>2</sub>.
- Performances améliorées pour une consommation réduite et une stabilité de marche optimisée.

## Bomba diésel para sistemas Common Rail

Nuestras bombas diésel de alta presión fueron especialmente desarrolladas para la última generación de sistemas de inyección diésel Common Rail. Su diseño posibilita una construcción compacta y un peso reducido. La concepción permite presiones de hasta 2.500 bares.

Por esta razón, los sistemas diésel Piezo Common Rail de Continental ofrecen las siguientes ventajas:

- El cumplimiento de los límites de emisiones de escape actuales y futuros
- La reducción de la emisión de CO<sub>2</sub>
- El incremento de la potencia con consumo reducido y estabilidad de marcha optimizada

## Pompe diesel common rail

Le nostre pompe ad alta pressione sono state progettate specificamente per l'ultima generazione di sistemi di iniezione common rail diesel. La loro concezione consente un design compatto ed un basso peso. Sono realizzate per sopportare pressioni sino a 2500 bar.

L'offerta di Continental di sistemi Piezoelettrici Common Rail garantisce i seguenti vantaggi :

- Conformità ai limiti di emissioni attuali e futuri
- Riduzione delle emissioni di CO<sub>2</sub>
- Aumento delle prestazioni, consumi ridotti e funzionamento ottimizzato

## Насосы для систем впрыска с общим нагнетательным трубопроводом типа Common Rail

Наши дизельные насосы высокого давления были специально разработаны для новейшего поколения систем впрыска с общим нагнетательным трубопроводом типа Common Rail. Их концепция обеспечивает компактность конструкции и незначительный вес. Расчетное давление составляет до 2.500 бар.

Тем самым системы впрыска с общим нагнетательным трубопроводом типа Piezo-Common Rail фирмы Continental дают следующие преимущества:

- Соблюдение текущих и будущих предельных показателей выброса ОГ
- Снижение выброса CO<sub>2</sub>
- Повышение мощности при снижении расхода и оптимизированный плавный ход



## Product Information

Produktinformationen

Information produit

Información del producto

Informazioni sul prodotto

Информация О Продукте



**5WS4000-Z****Diesel common rail piezo injector**

Diesel (V65)

Observe the vehicle manufacturer specifications (C27)

T024: Mandatory - check new part against old part (in particular OE No.)

**CITROËN**

BERLINGO (MF) / BERLINGO Box (M\_) / C5 I (DC\_) / C5 I Break (DE\_) / XSARA (N1) / XSARA Break (N2) / XSARA Coupe (N0)

**PEUGEOT**

307 (3A/C) / 307 Break (3E) / 307 SW (3H) / 406 (8B) / 406 Break (8E/F) / PARTNER Box (5) / PARTNER Combispace (5F)

**5WS4008-Z****Diesel common rail pump**

Diesel (V65)

Observe the vehicle manufacturer specifications (C27)

T024: Mandatory - check new part against old part (in particular OE No.)

**CITROËN**

C2 (JM\_) / C2 ENTERPRISE / C3 I (FC\_) / C3 II / C3 Pluriel (HB\_)

**FORD**

FIESTA V (JH\_, JD\_) / FIESTA V Van / FIESTA VI / FIESTA VI Van / FUSION (JU\_)

**PEUGEOT**

107 / 1007 (KM\_)

**TOYOTA**

AYGO (WNB1\_, KGB1\_)

**5WS40148-Z****Diesel common rail piezo injector**

Diesel (V65)

Observe the vehicle manufacturer specifications (C27)

T024: Mandatory - check new part against old part (in particular OE No.)

**CITROËN**

C3 Pluriel (HB\_)

**FORD**

FUSION (JU\_)

**PEUGEOT**

1007 (KM\_)



## 5WS40156-4Z

**Diesel common rail piezo injector**

Version (C2): 4

Diesel (V65)

Observe the vehicle manufacturer specifications (C27)

T024: Mandatory - check new part against old part (in particular OE No.)

T041: Please note the classification of the injector (4, 5 or 6).

**CITROËN**

C4 I (LC\_) / C4 Coupe (LA\_) / C5 II (RC\_) / C5 II Break (RE\_)

**FIAT**

SCUDO (272, 270) / SCUDO Box (272, 270) / SCUDO Platform/Chassis (272, 270) / ULYSSE (179AX)

**FORD**

C-MAX (DM2) / FOCUS II (DA\_) / FOCUS II Convertible / FOCUS II Estate (DA\_) / FOCUS II Saloon (DA\_) / FOCUS C-MAX / GALAXY (WA6) / KUGA I / MONDEO IV (BA7) / MONDEO IV Saloon (BA7) / MONDEO IV Turnier (BA7) / S-MAX (WA6)

**PEUGEOT**

307 (3A/C) / 307 Break (3E) / 307 CC (3B) / 307 SW (3H) / 407 (6D\_) / 407 Coupe (6C\_) / 407 SW (6E\_) / 807 (E) / EXPERT Box (VF3A\_, VF3U\_, VF3X\_) / EXPERT Platform/Chassis / EXPERT Tepee (VF3V\_)

**VOLVO**

C30 / C70 II Convertible / S40 II (MS) / S80 II (AS) / V50 (MW) / V70 III (BW)

## 5WS40156-Z

**Diesel common rail piezo injector**

Version (C2): 5

Diesel (V65)

Observe the vehicle manufacturer specifications (C27)

T024: Mandatory - check new part against old part (in particular OE No.)

T041: Please note the classification of the injector (4, 5 or 6).

**CITROËN**

C4 I (LC\_) / C4 Coupe (LA\_) / C5 II (RC\_) / C5 II Break (RE\_)

**FIAT**

SCUDO (272, 270) / SCUDO Box (272, 270) / SCUDO Platform/Chassis (272, 270) / ULYSSE (179AX)

**FORD**

C-MAX (DM2) / FOCUS II (DA\_) / FOCUS II Convertible / FOCUS II Estate (DA\_) / FOCUS II Saloon (DA\_) / FOCUS C-MAX / GALAXY (WA6) / KUGA I / MONDEO IV (BA7) / MONDEO IV Saloon (BA7) / MONDEO IV Turnier (BA7) / S-MAX (WA6)

**PEUGEOT**

307 (3A/C) / 307 Break (3E) / 307 CC (3B) / 307 SW (3H) / 407 (6D\_) / 407 Coupe (6C\_) / 407 SW (6E\_) / 607 (9D, 9U) / 807 (E) / EXPERT Box (VF3A\_, VF3U\_, VF3X\_) / EXPERT Platform/Chassis / EXPERT Tepee (VF3V\_)

**VOLVO**

C30 / C70 II Convertible / S40 II (MS) / S80 II (AS) / V50 (MW) / V70 III (BW)





## 5WS40809-Z

**Diesel common rail pump**

Diesel (V65)

Observe the vehicle manufacturer specifications (C27)

T024: Mandatory - check new part against old part (in particular OE No.)

**CITROËN**

C4 Grand Picasso I (UA\_) / C4 Picasso I (UD\_) / C5 II (RC\_) / C5 II Break (RE\_) / C8 (EA\_, EB\_) / JUMPY / JUMPY Box

**FIAT**

SCUDO (272, 270) / SCUDO Box (272, 270) / SCUDO Platform/Chassis (272, 270) / ULYSSE (179AX)

**FORD**

FOCUS II (DA\_) / FOCUS II Convertible / FOCUS II Estate (DA\_) / FOCUS II Saloon (DA\_) / FOCUS C-MAX

**PEUGEOT**

307 (3A/C) / 307 Break (3E) / 307 CC (3B) / 307 SW (3H) / 407 (6D\_) / 407 Coupe (6C\_) / 407 SW (6E\_) / 607 (9D, 9U) / 807 (E) / EXPERT Box (VF3A\_, VF3U\_, VF3X\_) / EXPERT Platform/Chassis / EXPERT Tepee (VF3V\_)

## A2C59507596

**Diesel common rail piezo injector**

Diesel (V65)

Observe the vehicle manufacturer specifications (C27)

T024: Mandatory - check new part against old part (in particular OE No.)

**MERCEDES-BENZ**

A-CLASS (W176) / B-CLASS (W246, W242) / CITAN Box (415) / CITAN Combi (415) / CITAN Mixto (415) / CLA Coupe (C117) / CLA Shooting Brake (X117) / GLA-CLASS (X156)

**NISSAN**

JUKE (F15) / NV200 / EVALIA Bus / NV200 Box / QASHQAI (J11, J11\_)

**RENAULT**

CAPTUR / GRAND SCÉNIC III (JZ0/1\_) / KADJAR / KANGOO / GRAND KANGOO (KW0/1\_) / KANGOO Express (FW0/1\_) / MEGANE III Grandtour (KZ0/1) / MEGANE III Hatchback (BZ0\_) / SCÉNIC III (JZ0/1\_)

## A2C59507608

**Diesel common rail pump**

Diesel (V65)

Observe the vehicle manufacturer specifications (C27)

T024: Mandatory - check new part against old part (in particular OE No.)

**MERCEDES-BENZ**

A-CLASS (W176) / B-CLASS (W246, W242) / CITAN Box (415) / CITAN Combi (415) / CITAN Mixto (415) / CLA Coupe (C117) / CLA Shooting Brake (X117) / GLA-CLASS (X156)

**NISSAN**

JUKE (F15) / NV200 / EVALIA Bus / NV200 Box / QASHQAI (J11, J11\_)

**RENAULT**

CAPTUR / GRAND SCÉNIC III (JZ0/1\_) / KADJAR / KANGOO / GRAND KANGOO (KW0/1\_) / KANGOO Express (FW0/1\_) / MEGANE III Grandtour (KZ0/1) / MEGANE III Hatchback (BZ0\_) / SCÉNIC III (JZ0/1\_)



## A2C59511314

**Diesel common rail pump**

Diesel (V65)

Observe the vehicle manufacturer specifications (C27)

T024: Mandatory - check new part against old part (in particular OE No.)

**CITROËN**

C5 III (RD\_) / C5 III Break (TD\_) / C6 (TD\_)

**JAGUAR**

S-TYPE (CCX) / XF (\_J05\_, CC9)

**LAND ROVER**

DISCOVERY III (TAA, LA\_) / RANGE ROVER SPORT (LS)

**PEUGEOT**

407 (6D\_) / 407 Coupe (6C\_) / 407 SW (6E\_) / 607 (9D, 9U)

## A2C59511315

**Diesel common rail piezo injector**

Diesel (V65)

Observe the vehicle manufacturer specifications (C27)

T024: Mandatory - check new part against old part (in particular OE No.)

## A2C59511316

**Diesel common rail piezo injector**

Diesel (V65)

Observe the vehicle manufacturer specifications (C27)

T024: Mandatory - check new part against old part (in particular OE No.)

**CITROËN**

C5 III (RD\_) / C5 III Break (TD\_) / C6 (TD\_)

**JAGUAR**

S-TYPE (CCX) / XF (\_J05\_, CC9)

**PEUGEOT**

407 (6D\_) / 407 Coupe (6C\_) / 407 SW (6E\_) / 607 (9D, 9U)

## A2C59511364

**Diesel common rail piezo injector**

Diesel (V65)

Observe the vehicle manufacturer specifications (C27)

T024: Mandatory - check new part against old part (in particular OE No.)

**LAND ROVER**

DISCOVERY III (TAA, LA\_) / RANGE ROVER SPORT (LS)

**A2C59511600****Diesel common rail pump**

Diesel (V65)

Observe the vehicle manufacturer specifications (C27)

T024: Mandatory - check new part against old part (in particular OE No.)

**FORD**

C-MAX (DM2) / FOCUS II (DA\_) / FOCUS II Convertible / FOCUS II Estate (DA\_) / FOCUS II Saloon (DA\_) / FOCUS C-MAX / GALAXY (WA6) / KUGA I / MONDEO IV (BA7) / MONDEO IV Saloon (BA7) / MONDEO IV Turnier (BA7) / S-MAX (WA6)

**VOLVO**

C30 / C70 II Convertible / S40 II (MS) / S80 II (AS) / V50 (MW) / V70 III (BW)

**A2C59511601****Diesel common rail piezo injector**

Version (C2): 6



Diesel (V65)

Observe the vehicle manufacturer specifications (C27)

T024: Mandatory - check new part against old part (in particular OE No.)

T041: Please note the classification of the injector (4, 5 or 6).

**CITROËN**

C4 I (LC\_) / C4 Coupe (LA\_) / C5 II (RC\_) / C5 II Break (RE\_)

**FIAT**

SCUDO (272, 270) / SCUDO Box (272, 270) / SCUDO Platform/Chassis (272, 270) / ULYSSE (179AX)

**FORD**

C-MAX (DM2) / FOCUS II (DA\_) / FOCUS II Convertible / FOCUS II Estate (DA\_) / FOCUS II Saloon (DA\_) / FOCUS C-MAX / GALAXY (WA6) / KUGA I / MONDEO IV (BA7) / MONDEO IV Saloon (BA7) / MONDEO IV Turnier (BA7) / S-MAX (WA6)

**PEUGEOT**

307 (3A/C) / 307 Break (3E) / 307 CC (3B) / 307 SW (3H) / 407 (6D\_) / 407 Coupe (6C\_) / 407 SW (6E\_) / 807 (E) / EXPERT Box (VF3A\_, VF3U\_, VF3X\_) / EXPERT Platform/Chassis / EXPERT Tepee (VF3V\_)

**A2C59511602****Diesel common rail piezo injector**

Diesel (V65)

Observe the vehicle manufacturer specifications (C27)

T024: Mandatory - check new part against old part (in particular OE No.)

**CITROËN**

C8 (EA\_, EB\_) / JUMPY / JUMPY Box

**FIAT**

SCUDO (272, 270) / SCUDO Box (272, 270) / SCUDO Platform/Chassis (272, 270) / ULYSSE (179AX)

**PEUGEOT**

807 (E) / EXPERT Box (VF3A\_, VF3U\_, VF3X\_) / EXPERT Platform/Chassis / EXPERT Tepee (VF3V\_)



## A2C59511605

**Diesel common rail pump**

Diesel (V65)

Observe the vehicle manufacturer specifications (C27)

T024: Mandatory - check new part against old part (in particular OE No.)

**NISSAN**

NOTE (E11) / QASHQAI / QASHQAI +2 (J10, JJ10) / TIIDA Hatchback (C11X) / TIIDA Saloon (SC11X)

**RENAULT**

CLIO III (BR0/1, CR0/1) / CLIO Grandtour (KR0/1\_) / KANGOO / GRAND KANGOO (KW0/1\_) / KANGOO BE BOP (KW0/1\_) / KANGOO Express (FW0/1\_) / LAGUNA III (BT0/1) / LAGUNA III Grandtour (KT0/1) / MEGANE II (BM0/1\_, CM0/1\_) / MEGANE II Coupé-Cabriolet (EM0/1\_) / MEGANE II Estate (KM0/1\_) / MEGANE II Saloon (LM0/1\_) / MODUS / GRAND MODUS (F/JP0\_) / SCÉNIC II (JM0/1\_)

## A2C59511606

**Diesel common rail piezo injector**

Diesel (V65)

Observe the vehicle manufacturer specifications (C27)

T024: Mandatory - check new part against old part (in particular OE No.)

**NISSAN**

NOTE (E11) / QASHQAI / QASHQAI +2 (J10, JJ10) / TIIDA Hatchback (C11X) / TIIDA Saloon (SC11X)

**RENAULT**

CLIO III (BR0/1, CR0/1) / CLIO Grandtour (KR0/1\_) / KANGOO / GRAND KANGOO (KW0/1\_) / KANGOO BE BOP (KW0/1\_) / KANGOO Express (FW0/1\_) / LAGUNA III (BT0/1) / LAGUNA III Grandtour (KT0/1) / MEGANE II (BM0/1\_, CM0/1\_) / MEGANE II Coupé-Cabriolet (EM0/1\_) / MEGANE II Estate (KM0/1\_) / MEGANE II Saloon (LM0/1\_) / MODUS / GRAND MODUS (F/JP0\_) / SCÉNIC II (JM0/1\_)

## A2C59511609

**Diesel common rail pump**

Diesel (V65)

Observe the vehicle manufacturer specifications (C27)

T024: Mandatory - check new part against old part (in particular OE No.)

**FORD**

C-MAX (DM2) / FOCUS (DAW, DBW) / FOCUS II (DA\_) / FOCUS II Estate (DA\_) / FOCUS II Saloon (DA\_) / FOCUS C-MAX / FOCUS Estate (DNW) / FOCUS Saloon (DFW) / GALAXY (WA6) / MONDEO IV (BA7) / MONDEO IV Saloon (BA7) / MONDEO IV Turnier (BA7) / S-MAX (WA6) / TOURNEO CONNECT / TRANSIT CONNECT (P65\_, P70\_, P80\_)

## A2C59511610

**Diesel common rail piezo injector**

Diesel (V65)

Observe the vehicle manufacturer specifications (C27)

T024: Mandatory - check new part against old part (in particular OE No.)

**FORD**

C-MAX (DM2) / FOCUS (DAW, DBW) / FOCUS II (DA\_) / FOCUS II Estate (DA\_) / FOCUS II Saloon (DA\_) / FOCUS C-MAX / FOCUS Estate (DNW) / FOCUS Saloon (DFW) / GALAXY (WA6) / MONDEO IV (BA7) / MONDEO IV Saloon (BA7) / MONDEO IV Turnier (BA7) / S-MAX (WA6) / TOURNEO CONNECT / TRANSIT CONNECT (P65\_, P70\_, P80\_)



## A2C59511611

**Diesel common rail piezo injector**

Diesel (V65)

Observe the vehicle manufacturer specifications (C27)

T024: Mandatory - check new part against old part (in particular OE No.)

**FORD**

TOURNEO CONNECT / TRANSIT CONNECT (P65\_, P70\_, P80\_)

## A2C59511612

**Diesel common rail piezo injector**

Diesel (V65)

Observe the vehicle manufacturer specifications (C27)

T024: Mandatory - check new part against old part (in particular OE No.)

**CITROËN**

C2 (JM\_) / C2 ENTERPRISE / C3 I (FC\_) / C3 II

**FORD**

FIESTA V (JH\_, JD\_) / FIESTA V Van / FIESTA VI / FIESTA VI Van / FUSION (JU\_)

**PEUGEOT**

107 / 1007 (KM\_)

**TOYOTA**

AYGO (WNB1\_, KGB1\_)

## A2C59513481

**Diesel common rail pump**

Diesel (V65)

Observe the vehicle manufacturer specifications (C27)

T024: Mandatory - check new part against old part (in particular OE No.)

**LAND ROVER**

RANGE ROVER III (LM) / RANGE ROVER SPORT (LS)

## A2C59513482

**Diesel common rail pump**

Diesel (V65)

Observe the vehicle manufacturer specifications (C27)

T024: Mandatory - check new part against old part (in particular OE No.)

**LAND ROVER**

DISCOVERY III (TAA, LA\_) / DISCOVERY IV (LA) / RANGE ROVER SPORT (LS)



## A2C59513484

**Diesel common rail piezo injector**

Diesel (V65)

Observe the vehicle manufacturer specifications (C27)

T019: Have to be taught/updated.

T024: Mandatory - check new part against old part (in particular OE No.)

**DACIA**

DUSTER / DUSTER Box / LODGY

**NISSAN**

CUBE (Z12) / JUKE (F15) / QASHQAI / QASHQAI +2 (J10, JJ10)

**RENAULT**

CLIO III (BR0/1, CR0/1) / CLIO Grandtour (KR0/1\_) / FLUENCE (L30\_) / GRAND SCÉNIC III (JZ0/1\_) / LAGUNA Coupe (DT0/1) / LATITUDE (L70\_) / MEGANE III Coupe (DZ0/1\_) / MEGANE III Grandtour (KZ0/1) / MEGANE III Hatchback (BZ0\_) / MEGANE CC (EZ0/1\_) / SCÉNIC III (JZ0/1\_)

## A2C59513552

**Diesel common rail piezo injector**

Diesel (V65)

Observe the vehicle manufacturer specifications (C27)

T024: Mandatory - check new part against old part (in particular OE No.)

**CITROËN**

C4 Grand Picasso I (UA\_) / C4 Picasso I (UD\_)

**PEUGEOT**

307 Break (3E) / 307 CC (3B) / 307 SW (3H) / 407 (6D\_) / 407 SW (6E\_)

## A2C59513553

**Diesel common rail piezo injector**

Diesel (V65)

Observe the vehicle manufacturer specifications (C27)

T024: Mandatory - check new part against old part (in particular OE No.)

**LAND ROVER**

DISCOVERY III (TAA, LA\_) / DISCOVERY IV (LA) / RANGE ROVER SPORT (LS)





## A2C59513554

**Diesel common rail piezo injector**

Diesel (V65)

Observe the vehicle manufacturer specifications (C27)

T019: Have to be taught/updated.

T024: Mandatory - check new part against old part (in particular OE No.)

**AUDI**

A1 (8X1, 8XK, 8XF) / A1 Sportback (8XA, 8XF, 8XK) / A3 (8P1) / A3 Convertible (8P7) / A3 Sportback (8PA)

**SEAT**

ALTEA (5P1) / ALTEA XL (5P5, 5P8) / IBIZA V (6J5, 6P1) / IBIZA V SPORTCOUPE (6J1, 6P5) / IBIZA V ST (6J8, 6P8) / LEON (1P1) / TOLEDO IV (KG3)

**SKODA**

FABIA / FABIA Combi / OCTAVIA (1Z3) / OCTAVIA Combi (1Z5) / RAPID (NH3) / RAPID Spaceback (NH1) / ROOMSTER (5J) / ROOMSTER Praktik (5J) / SUPERB (3T4) / SUPERB Estate (3T5) / YETI (5L)

**VW**

BEETLE (5C1) / BEETLE Convertible (5C7) / GOLF VI (5K1) / GOLF VI Convertible (517) / GOLF VI Variant (AJ5) / GOLF PLUS (5M1, 521) / JETTA III (1K2) / JETTA IV (162, 163) / PASSAT (3C2) / PASSAT (362) / PASSAT Variant (3C5) / PASSAT Variant (365) / POLO (6R, 6C) / TOURAN (1T3)

## A2C59513556

**Diesel common rail piezo injector**

Observe the vehicle manufacturer specifications (C27)

T019: Have to be taught/updated.

T024: Mandatory - check new part against old part (in particular OE No.)

**CITROËN**

BERLINGO (B9) / BERLINGO Box (B9) / BERLINGO Platform/Chassis (B9) / C3 II / C3 Picasso / C4 II (B7) / C4 AIRCROSS / C4 Grand Picasso I (UA\_) / C4 Picasso I (UD\_) / C4 Picasso II / C5 III (RD\_) / C5 III Break (TD\_) / DS3 / DS4 / DS5

**FORD**

C-MAX II (DXA/CB7, DXA/CEU) / FOCUS III / FOCUS III Saloon / FOCUS III Turnier / GALAXY (WA6) / GRAND C-MAX (DXA/CB7, DXA/CEU) / MONDEO IV (BA7) / MONDEO IV Turnier (BA7) / S-MAX (WA6)

**PEUGEOT**

207 CC (WD\_) / 207 SW (WK\_) / 208 / 308 (4A\_, 4C\_) / 308 II / 308 CC / 308 SW / 508 / 508 SW / 2008 / 3008 / 4008 / 5008 / PARTNER Box / PARTNER Tepee

**VOLVO**

C30 / S40 II (MS) / S60 II / S80 II (AS) / V40 Hatchback / V50 (MW) / V60 / V70 III (BW)

## A2C59513595

**Diesel common rail pump**

Diesel (V65)

Observe the vehicle manufacturer specifications (C27)

T024: Mandatory - check new part against old part (in particular OE No.)

**DACIA**

DUSTER / DUSTER Box / LODGY

**NISSAN**

CUBE (Z12) / JUKE (F15)

**RENAULT**

CLIO III (BR0/1, CR0/1) / CLIO Grandtour (KR0/1\_) / FLUENCE (L30\_) / GRAND SCÉNIC III (JZ0/1\_) / LAGUNA Coupe (DT0/1) / LATITUDE (L70\_) / MEGANE III Coupe (DZ0/1\_) / MEGANE III Grandtour (KZ0/1) / MEGANE III Hatchback (BZ0\_) / MEGANE CC (EZ0/1\_) / SCÉNIC III (JZ0/1\_)

**A2C59513596****Diesel common rail piezo injector**

Diesel (V65)

Observe the vehicle manufacturer specifications (C27)

T024: Mandatory - check new part against old part (in particular OE No.)

**A2C59513597****Diesel common rail piezo injector**

Diesel (V65)

Observe the vehicle manufacturer specifications (C27)

T024: Mandatory - check new part against old part (in particular OE No.)

**LAND ROVER**

RANGE ROVER III (LM) / RANGE ROVER SPORT (LS)

**A2C59513829****Diesel common rail pump**

Diesel (V65)

Observe the vehicle manufacturer specifications (C27)

T024: Mandatory - check new part against old part (in particular OE No.)

**FORD**

C-MAX II (DXA/CB7, DXA/CEU) / FOCUS III / FOCUS III Saloon / FOCUS III Turnier / GALAXY (WA6) / GRAND C-MAX (DXA/CB7, DXA/CEU) / MONDEO IV (BA7) / MONDEO IV Turnier (BA7) / S-MAX (WA6)

**VOLVO**

C30 / S40 II (MS) / S60 II / S80 II (AS) / V40 Hatchback / V50 (MW) / V60 / V70 III (BW)

**A2C59513830****Diesel common rail pump**

Diesel (V65)

Observe the vehicle manufacturer specifications (C27)

T024: Mandatory - check new part against old part (in particular OE No.)

**CITROËN**

BERLINGO (B9) / BERLINGO Box (B9) / BERLINGO Platform/Chassis (B9) / C3 II / C3 Picasso / C4 II (B7) / C4 AIRCROSS / C4 Grand Picasso I (UA\_) / C4 Picasso I (UD\_) / C4 Picasso II / C5 III (RD\_) / C5 III Break (TD\_) / DS3 / DS4 / DS5

**PEUGEOT**

207 CC (WD\_) / 207 SW (WK\_) / 208 / 308 (4A\_, 4C\_) / 308 II / 308 CC / 308 SW / 508 / 508 SW / 2008 / 3008 / 4008 / 5008 / PARTNER Box / PARTNER Tepee

**A2C59517043****Diesel common rail pump**

Diesel (V65)

Observe the vehicle manufacturer specifications (C27)

T024: Mandatory - check new part against old part (in particular OE No.)

**FORD**

RANGER (TKE) / TRANSIT Box / TRANSIT Bus / TRANSIT Platform/Chassis / TRANSIT TOURNEO

**LAND ROVER**

DEFENDER Cabrio (LD) / DEFENDER Pickup (LD\_) / DEFENDER Platform/Chassis (LD) / DEFENDER Station Wagon (LD)

**A2C59517045****Diesel common rail pump**

Diesel (V65)

Observe the vehicle manufacturer specifications (C27)

T024: Mandatory - check new part against old part (in particular OE No.)

**CITROËN**

JUMPER Box / JUMPER Bus / JUMPER Platform/Chassis

**FORD**

TOURNEO CUSTOM Bus / TRANSIT Box / TRANSIT Bus / TRANSIT CUSTOM Box / TRANSIT CUSTOM Bus / TRANSIT Platform/Chassis

**PEUGEOT**

BOXER Box / BOXER Bus / BOXER Platform/Chassis

**A2C59517047****Diesel common rail pump**

Diesel (V65)

Observe the vehicle manufacturer specifications (C27)

T024: Mandatory - check new part against old part (in particular OE No.)

**AUDI**

A3 (8P1) / A3 Convertible (8P7) / A3 Sportback (8PA)

**SEAT**

ALTEA (5P1) / IBIZA V (6J5, 6P1) / IBIZA V SPORTCOUPE (6J1, 6P5) / IBIZA V ST (6J8, 6P8) / LEON (1P1) / TOLEDO IV (KG3)

**SKODA**

FABIA / OCTAVIA (1Z3) / OCTAVIA Combi (1Z5) / RAPID (NH3) / RAPID Spaceback (NH1) / SUPERB (3T4) / YETI (5L)

**VW**

BEETLE (5C1) / BEETLE Convertible (5C7) / CADDY III Box (2KA, 2KH, 2CA, 2CH) / CADDY III Estate (2KB, 2KJ, 2CB, 2CJ) / CADDY IV Box (SAA, SAH) / CADDY IV Estate (SAB, SAJ) / GOLF VI Convertible (517) / GOLF VI Variant (AJ5) / GOLF PLUS (5M1, 521) / JETTA III (1K2) / JETTA IV (162, 163) / PASSAT Variant (3C5) / POLO (6R, 6C) / TOURAN (1T3)



**A2C59517049**



**Diesel common rail pump**



Diesel (V65)

Observe the vehicle manufacturer specifications (C27)

T024: Mandatory - check new part against old part (in particular OE No.)

**AUDI**

A1 (8X1, 8XK, 8XF) / A1 Sportback (8XA, 8XF, 8XK)

**SKODA**

RAPID (NH3) / RAPID Spaceback (NH1)

**VW**

PASSAT (362) / PASSAT Variant (365)

**A2C59517051**



**Diesel common rail piezo injector**



Diesel (V65)

Observe the vehicle manufacturer specifications (C27)

T019: Have to be taught/updated.

T024: Mandatory - check new part against old part (in particular OE No.)

**CITROËN**

JUMPER Box / JUMPER Bus / JUMPER Platform/Chassis

**FORD**

RANGER (TKE) / TOURNEO CUSTOM Bus / TRANSIT Box / TRANSIT Bus / TRANSIT CUSTOM Box / TRANSIT CUSTOM Bus / TRANSIT Platform/Chassis / TRANSIT TOURNEO

**PEUGEOT**

BOXER Box / BOXER Bus / BOXER Platform/Chassis



## **Manufacturer Index**

Herstellerverzeichnis

Les fabricants

Directorio de fabricantes

Elenco produttori

Производители Каталог



|                                    |    |  |  |
|------------------------------------|----|--|--|
| <b>A</b>                           |    |  |  |
| AUDI                               | 23 |  |  |
| A1 (8X1, 8XK, 8XF)                 | 23 |  |  |
| A1 Sportback (8XA, 8XF, 8XK)       | 23 |  |  |
| A3 (8P1)                           | 23 |  |  |
| A3 Convertible (8P7)               | 23 |  |  |
| A3 Sportback (8PA)                 | 23 |  |  |
| <b>C</b>                           |    |  |  |
| CITROËN                            | 23 |  |  |
| BERLINGO (B9)                      | 23 |  |  |
| BERLINGO (MF)                      | 23 |  |  |
| BERLINGO Box (B9)                  | 24 |  |  |
| BERLINGO I Box (M_)                | 23 |  |  |
| BERLINGO Platform/Chassis (B9)     | 24 |  |  |
| C2 (JM_)                           | 24 |  |  |
| C2 ENTERPRISE                      | 24 |  |  |
| C3 I (FC_)                         | 24 |  |  |
| C3 II                              | 24 |  |  |
| C3 Picasso                         | 24 |  |  |
| C3 Pluriel (HB_)                   | 25 |  |  |
| C4 AIRCROSS                        | 25 |  |  |
| C4 Coupe (LA_)                     | 25 |  |  |
| C4 Grand Picasso I (JA_)           | 25 |  |  |
| C4 I (LC_)                         | 25 |  |  |
| C4 II (B7)                         | 25 |  |  |
| C4 Picasso I (JD_)                 | 26 |  |  |
| C4 Picasso II                      | 26 |  |  |
| C5 I (DC_)                         | 26 |  |  |
| C5 I Break (DE_)                   | 26 |  |  |
| C5 II (RC_)                        | 26 |  |  |
| C5 II Break (RE_)                  | 26 |  |  |
| C5 III Break (TD_)                 | 26 |  |  |
| C5 III Saloon (RD_)                | 27 |  |  |
| C6 Saloon (TD_)                    | 27 |  |  |
| C8 (EA_, EB_)                      | 27 |  |  |
| DISPATCH Box                       | 27 |  |  |
| DS3                                | 27 |  |  |
| DS4                                | 27 |  |  |
| DS5                                | 28 |  |  |
| JUMPER Box                         | 28 |  |  |
| JUMPER Bus                         | 28 |  |  |
| JUMPER Platform/Chassis            | 28 |  |  |
| JUMPY                              | 28 |  |  |
| XSARA (N1)                         | 28 |  |  |
| XSARA Break (N2)                   | 28 |  |  |
| XSARA Coupe (N0)                   | 28 |  |  |
| <b>D</b>                           |    |  |  |
| DACIA                              | 28 |  |  |
| DUSTER                             | 29 |  |  |
| DUSTER Box                         | 29 |  |  |
| LODGY                              | 29 |  |  |
| <b>F</b>                           |    |  |  |
| FIAT                               | 29 |  |  |
| SCUDO (272, 270)                   | 29 |  |  |
| SCUDO Box (272, 270)               | 29 |  |  |
| SCUDO Platform/Chassis (272, 270)  | 30 |  |  |
| ULYSSE (179AX)                     | 30 |  |  |
| <b>FORD</b>                        | 30 |  |  |
| C-MAX (DM2)                        | 30 |  |  |
| C-MAX II (DXA/CB7, DXA/CEU)        | 30 |  |  |
| FIESTA V (JH_, JD_)                | 30 |  |  |
| FIESTA VI                          | 31 |  |  |
| FIESTA VI Van                      | 31 |  |  |
| FIESTA V Van                       | 31 |  |  |
| FOCUS (DAW, DBW)                   | 31 |  |  |
| FOCUS C-MAX                        | 33 |  |  |
| FOCUS Estate (DNW)                 | 33 |  |  |
| FOCUS II (DA_)                     | 31 |  |  |
| FOCUS II Convertible               | 31 |  |  |
| FOCUS II Estate (DA_)              | 31 |  |  |
| FOCUS III                          | 32 |  |  |
| FOCUS III Saloon                   | 32 |  |  |
| FOCUS III Turnier                  | 32 |  |  |
| FOCUS II Saloon (DA_)              | 32 |  |  |
| FOCUS Saloon (DFW)                 | 33 |  |  |
| FUSION (JU_)                       | 33 |  |  |
| GALAXY (WA6)                       | 33 |  |  |
| GRAND C-MAX (DXA/CB7, DXA/CEU)     | 34 |  |  |
| KUGA I                             | 34 |  |  |
| MONDEO IV (BA7)                    | 34 |  |  |
| MONDEO IV Saloon (BA7)             | 35 |  |  |
| MONDEO IV Turnier (BA7)            | 35 |  |  |
| RANGER (TKE)                       | 36 |  |  |
| S-MAX (WA6)                        | 36 |  |  |
| TOURNEO CONNECT                    | 36 |  |  |
| TOURNEO CUSTOM Bus                 | 37 |  |  |
| TRANSIT Box                        | 37 |  |  |
| TRANSIT Bus                        | 38 |  |  |
| TRANSIT CONNECT (P65_, P70_, P80_) | 39 |  |  |
| TRANSIT CUSTOM Box                 | 39 |  |  |
| TRANSIT CUSTOM Bus                 | 39 |  |  |
| TRANSIT Platform/Chassis           | 39 |  |  |
| TRANSIT TOURNEO                    | 40 |  |  |
| <b>J</b>                           |    |  |  |
| JAGUAR                             | 40 |  |  |
| S-TYPE Saloon (CCX)                | 40 |  |  |
| XF Saloon (_J05_, CC9)             | 40 |  |  |
| <b>L</b>                           |    |  |  |
| LAND ROVER                         | 40 |  |  |
| DEFENDER Cabrio (LD)               | 41 |  |  |
| DEFENDER Pickup (LD_)              | 41 |  |  |
| DEFENDER Platform/Chassis (LD)     | 41 |  |  |
| DEFENDER Station Wagon (LD)        | 41 |  |  |
| DISCOVERY III (TAA, LA_)           | 41 |  |  |
| DISCOVERY IV (LA)                  | 41 |  |  |
| RANGE ROVER III (LM)               | 41 |  |  |
| RANGE ROVER SPORT (LS)             | 41 |  |  |
| <b>M</b>                           |    |  |  |
| MERCEDES-BENZ                      | 42 |  |  |
| A-CLASS (W176)                     | 42 |  |  |
| B-CLASS (W246, W242)               | 42 |  |  |
| CITAN Box (415)                    | 42 |  |  |
| CITAN Combi (415)                  | 42 |  |  |
| CITAN Mixto (415)                  | 42 |  |  |
| CLA Coupe (C117)                   | 43 |  |  |
| CLA Shooting Brake (X117)          | 43 |  |  |
| GLA-CLASS (X156)                   | 43 |  |  |
| <b>N</b>                           |    |  |  |
| NISSAN                             | 43 |  |  |
| CUBE (Z12)                         | 43 |  |  |
| DUALIS (J10, JJ10)                 | 43 |  |  |
| JUKE (F15)                         | 43 |  |  |
| NOTE (E11)                         | 43 |  |  |
| NV200 / EVALIA Bus                 | 43 |  |  |
| NV200 Box                          | 44 |  |  |
| QASHQAI (J11, J11_)                | 44 |  |  |
| TIIDA Hatchback (C11X)             | 44 |  |  |
| TIIDA Saloon (SC11X)               | 44 |  |  |
| <b>P</b>                           |    |  |  |
| PEUGEOT                            | 44 |  |  |
| 1007 (KM_)                         | 48 |  |  |
| 107                                | 44 |  |  |
| 2008                               | 48 |  |  |
| 207 CC (WD_)                       | 44 |  |  |
| 207 SW Estate (WK_)                | 44 |  |  |
| 208                                | 45 |  |  |
| 3008                               | 48 |  |  |
| 307 (3A/C)                         | 45 |  |  |
| 307 Break (3E)                     | 45 |  |  |
| 307 CC (3B)                        | 45 |  |  |
| 307 SW (3H)                        | 45 |  |  |
| 308 (4A_, 4C_)                     | 45 |  |  |
| 308 CC                             | 46 |  |  |
| 308 II                             | 46 |  |  |
| 308 SW Estate                      | 46 |  |  |
| 4008                               | 48 |  |  |
| 406 Break (8E/F)                   | 46 |  |  |
| 406 Saloon (8B)                    | 46 |  |  |
| 407 Coupe (6C_)                    | 46 |  |  |
| 407 Saloon (6D_)                   | 47 |  |  |
| 407 SW (6E_)                       | 47 |  |  |
| 5008                               | 48 |  |  |
| 508                                | 47 |  |  |
| 508 SW                             | 47 |  |  |
| 607 Saloon (9D, 9U)                | 47 |  |  |
| 807 (E)                            | 48 |  |  |
| BOXER Box                          | 49 |  |  |
| BOXER Bus                          | 49 |  |  |
| BOXER Platform/Chassis             | 49 |  |  |
| EXPERT Box (VF3A_, VF3U_, VF3X_)   | 49 |  |  |
| EXPERT Platform/Chassis            | 49 |  |  |
| EXPERT Tepee (VF3V_)               | 49 |  |  |
| PARTNER Box                        | 50 |  |  |
| PARTNER Box (5)                    | 50 |  |  |
| PARTNER Combi (5F)                 | 50 |  |  |
| PARTNER Tepee                      | 50 |  |  |
| <b>R</b>                           |    |  |  |
| RENAULT                            | 50 |  |  |
| CAPTUR                             | 50 |  |  |
| CLIO Grandtour (KR0/1_)            | 50 |  |  |
| CLIO III (BR0/1, CR0/1)            | 50 |  |  |
| FLUENCE (L30_)                     | 51 |  |  |
| GRAND SCÉNIC III (JZ0/1_)          | 51 |  |  |
| KADJAR                             | 51 |  |  |
| KANGOO / GRAND KANGOO (KW0/1_)     | 51 |  |  |
| KANGOO BE BOP (KW0/1_)             | 51 |  |  |
| KANGOO Express (FW0/1_)            | 52 |  |  |
| LAGUNA Coupe (DT0/1)               | 52 |  |  |
| LAGUNA III (BT0/1)                 | 52 |  |  |
| LAGUNA III Grandtour (KT0/1)       | 52 |  |  |
| LATITUDE (L70_)                    | 52 |  |  |
| MEGANE CC (EZ0/1_)                 | 53 |  |  |
| MEGANE II (BM0/1_, CM0/1_)         | 52 |  |  |
| MEGANE II Coupé-Cabriolet (EM0/1_) | 52 |  |  |
| MEGANE II Estate (KM0/1_)          | 53 |  |  |
| MEGANE III Coupe (DZ0/1_)          | 53 |  |  |
| MEGANE III Grandtour (KZ0/1)       | 53 |  |  |
| MEGANE III Hatchback (BZ0_)        | 53 |  |  |
| MEGANE II Saloon (LM0/1_)          | 53 |  |  |
| MODUS / GRAND MODUS (F/JP0_)       | 54 |  |  |
| SCÉNIC II (JM0/1_)                 | 54 |  |  |
| SCÉNIC III (JZ0/1_)                | 54 |  |  |
| <b>S</b>                           |    |  |  |
| SEAT                               | 54 |  |  |
| ALTEA (5P1)                        | 54 |  |  |
| ALTEA XL (5P5, 5P8)                | 54 |  |  |
| IBIZA V (6J5, 6P1)                 | 54 |  |  |
| IBIZA V SPORTCOUPE (6J1, 6P5)      | 54 |  |  |
| IBIZA V ST (6J8, 6P8)              | 55 |  |  |
| LEON (1P1)                         | 55 |  |  |
| TOLEDO IV (KG3)                    | 55 |  |  |
| <b>SKODA</b>                       | 55 |  |  |
| FABIA                              | 55 |  |  |
| FABIA Combi                        | 55 |  |  |



|                                       |    |
|---------------------------------------|----|
| OCTAVIA (1Z3)                         | 55 |
| OCTAVIA Combi (1Z5)                   | 55 |
| RAPID (NH3)                           | 56 |
| RAPID Spaceback (NH1)                 | 56 |
| ROOMSTER (5J)                         | 56 |
| ROOMSTER Praktik (5J)                 | 56 |
| SUPERB (3T4)                          | 56 |
| SUPERB Estate (3T5)                   | 56 |
| YETI (5L)                             | 56 |
| <b>T</b>                              |    |
| TOYOTA                                | 56 |
| AYGO (WNB1_, KGB1_)                   | 56 |
| <b>V</b>                              |    |
| VOLVO                                 | 56 |
| C30                                   | 56 |
| C70 II Convertible                    | 57 |
| S40 II Saloon (MS)                    | 57 |
| S60 II                                | 57 |
| S80 II Saloon (AS)                    | 57 |
| V40 Hatchback                         | 57 |
| V50 Estate (MW)                       | 57 |
| V60                                   | 58 |
| V70 III (BW)                          | 58 |
| <b>VW</b>                             | 58 |
| BEETLE (5C1)                          | 58 |
| BEETLE Convertible (5C7)              | 58 |
| CADDY III Box (2KA, 2KH, 2CA, 2CH)    | 58 |
| CADDY III Estate (2KB, 2KJ, 2CB, 2CJ) | 58 |
| CADDY IV Box (SAA, SAH)               | 58 |
| CADDY IV Estate (SAB, SAJ)            | 58 |
| GOLF PLUS (6M1, 521)                  | 59 |
| GOLF VI (5K1)                         | 58 |
| GOLF VI Convertible (517)             | 58 |
| GOLF VI Variant (AJ5)                 | 59 |
| JETTA I Saloon (1K2)                  | 59 |
| JETTA IV (162, 163)                   | 59 |
| PASSAT (362)                          | 59 |
| PASSAT Saloon (3C2)                   | 59 |
| PASSAT Variant (365)                  | 60 |
| PASSAT Variant (3C5)                  | 59 |
| POLO (6R, 6C)                         | 60 |
| TOURAN (1T3)                          | 60 |



## **Product Application**

Produktverwendungen

Utilisations du produit

Aplicaciones el producto

Usi del prodotto

использование продукта





|   |       |             |  |                           |  | VDO         |    |
|---|-------|-------------|--|---------------------------|--|-------------|----|
| <b>AUDI - A1 (8X1, 8XK, 8XF) 05/10→</b>           |       |             |  |                           |  |             |    |
| <b>Diesel common rail piezo injector</b>          |       |             |  |                           |  |             |    |
| 1.6 TDI   | 66 kW | 03/11→      |  | CAYB                      |  | A2C59513554 | 15 |
| 1.6 TDI   | 77 kW | 05/10→      |  | CAYC                      |  | A2C59513554 | 15 |
| <b>Diesel common rail pump</b>                    |       |             |  |                           |  |             |    |
| 1.6 TDI   | 66 kW | 03/11→      |  | CAYB                      |  | A2C59517049 | 18 |
| <b>AUDI - A1 Sportback (8XA, 8XF, 8XK) 11/11→</b> |       |             |  |                           |  |             |    |
| <b>Diesel common rail piezo injector</b>          |       |             |  |                           |  |             |    |
| 1.6 TDI   | 66 kW | 11/11→      |  | CAYB                      |  | A2C59513554 | 15 |
| 1.6 TDI   | 77 kW | 11/11→      |  | CAYC                      |  | A2C59513554 | 15 |
| <b>Diesel common rail pump</b>                    |       |             |  |                           |  |             |    |
| 1.6 TDI   | 66 kW | 11/11→      |  | CAYB                      |  | A2C59517049 | 18 |
| <b>AUDI - A3 (8P1) 05/09→08/12</b>                |       |             |  |                           |  |             |    |
| <b>Diesel common rail piezo injector</b>          |       |             |  |                           |  |             |    |
| 1.6 TDI   | 66 kW | 05/09→08/12 |  | CAYB                      |  | A2C59513554 | 15 |
| 1.6 TDI   | 77 kW | 05/09→08/12 |  | CAYC                      |  | A2C59513554 | 15 |
| <b>Diesel common rail pump</b>                    |       |             |  |                           |  |             |    |
| 1.6 TDI   | 66 kW | 05/09→08/12 |  | CAYB                      |  | A2C59517047 | 17 |
| 1.6 TDI   | 77 kW | 05/09→08/12 |  | CAYC                      |  | A2C59517047 | 17 |
| <b>AUDI - A3 Convertible (8P7) 05/09→05/13</b>    |       |             |  |                           |  |             |    |
| <b>Diesel common rail piezo injector</b>          |       |             |  |                           |  |             |    |
| 1.6 TDI   | 77 kW | 05/09→05/13 |  | CAYC                      |  | A2C59513554 | 15 |
| <b>Diesel common rail pump</b>                    |       |             |  |                           |  |             |    |
| 1.6 TDI   | 77 kW | 05/09→05/13 |  | CAYC                      |  | A2C59517047 | 17 |
| <b>AUDI - A3 Sportback (8PA) 05/09→03/13</b>      |       |             |  |                           |  |             |    |
| <b>Diesel common rail piezo injector</b>          |       |             |  |                           |  |             |    |
| 1.6 TDI   | 66 kW | 05/09→03/13 |  | CAYB                      |  | A2C59513554 | 15 |
| 1.6 TDI   | 77 kW | 05/09→03/13 |  | CAYC                      |  | A2C59513554 | 15 |
| <b>Diesel common rail pump</b>                    |       |             |  |                           |  |             |    |
| 1.6 TDI   | 66 kW | 05/09→03/13 |  | CAYB                      |  | A2C59517047 | 17 |
| 1.6 TDI   | 77 kW | 05/09→03/13 |  | CAYC                      |  | A2C59517047 | 17 |
| <b>CITROËN - BERLINGO (B9) 07/10→</b>             |       |             |  |                           |  |             |    |
| <b>Diesel common rail piezo injector</b>          |       |             |  |                           |  |             |    |
| 1.6 HDi 110                                       | 82 kW | 07/10→      |  | 9HR (DV6C);  03/10  12/11 |  | A2C59513556 | 15 |
|   |       |             |  | 9HR (DV6C);  12/11        |  | A2C59513556 | 15 |
| 1.6 HDi 115                                       | 84 kW | 07/10→      |  | 9HR (DV6C);  03/10  12/11 |  | A2C59513556 | 15 |
| <b>Diesel common rail pump</b>                    |       |             |  |                           |  |             |    |
| 1.6 HDi 110                                       | 82 kW | 07/10→      |  | 9HR (DV6C);  07/10        |  | A2C59513830 | 16 |
| 1.6 HDi 115                                       | 84 kW | 07/10→      |  |                           |  |             |    |
| <b>CITROËN - BERLINGO (MF) 12/99→</b>             |       |             |  |                           |  |             |    |
| <b>Diesel common rail piezo injector</b>          |       |             |  |                           |  |             |    |
| 2.0 HDi 90 (MFRHY)                                | 66 kW | 12/99→      |  | RHY (DW10TD)              |  | 5WS40000-Z  | 7  |
| <b>CITROËN - BERLINGO I Box (M_) 12/99→</b>       |       |             |  |                           |  |             |    |
| <b>Diesel common rail piezo injector</b>          |       |             |  |                           |  |             |    |
| 2.0 HDi 90 (MBRHY, MCRHY)                         | 66 kW | 12/99→      |  | RHY (DW10TD)              |  | 5WS40000-Z  | 7  |

**CITROËN - BERLINGO Box (B9) 07/10→**

| Diesel common rail piezo injector |       |        |                           |             |    |
|-----------------------------------|-------|--------|---------------------------|-------------|----|
| 1.6 HDi 110                       | 82 kW | 07/10→ | 9HR (DV6C);  03/10  12/11 | A2C59513556 | 15 |
|                                   |       |        | 9HR (DV6C);  12/11        | A2C59513556 | 15 |
| 1.6 HDi 115                       | 84 kW | 07/10→ | 9HL (DV6C);  03/10  12/11 | A2C59513556 | 15 |

| Diesel common rail pump |       |        |                    |             |    |
|-------------------------|-------|--------|--------------------|-------------|----|
| 1.6 HDi 110             | 82 kW | 07/10→ | 9HR (DV6C);  07/10 | A2C59513830 | 16 |
| 1.6 HDi 115             | 84 kW | 07/10→ | 9HL (DV6C);  07/10 | A2C59513830 | 16 |

**CITROËN - BERLINGO Platform/Chassis (B9) 04/08→**

| Diesel common rail piezo injector |       |        |              |             |    |
|-----------------------------------|-------|--------|--------------|-------------|----|
| 1.6 HDi 90                        | 66 kW | 04/08→ | 12/11        | A2C59513556 | 15 |
|                                   |       |        | 12/11        | A2C59513556 | 15 |
|                                   |       |        | 03/10  12/11 | A2C59513556 | 15 |

| Diesel common rail pump |       |        |       |             |    |
|-------------------------|-------|--------|-------|-------------|----|
| 1.6 HDi 90              | 66 kW | 04/08→ | 07/10 | A2C59513830 | 16 |

**CITROËN - C2 (JM\_) 09/03→**

| Diesel common rail piezo injector |       |        |             |             |    |
|-----------------------------------|-------|--------|-------------|-------------|----|
| 1.4 HDi                           | 50 kW | 09/03→ | 8HX (DV4TD) | A2C59511612 | 13 |

| Diesel common rail pump |       |        |             |            |   |
|-------------------------|-------|--------|-------------|------------|---|
| 1.4 HDi                 | 50 kW | 09/03→ | 8HX (DV4TD) | 5WS40008-Z | 7 |

**CITROËN - C2 ENTERPRISE 04/09→**

| Diesel common rail piezo injector |       |        |             |             |    |
|-----------------------------------|-------|--------|-------------|-------------|----|
| 1.4 HDi                           | 50 kW | 04/09→ | 8HX (DV4TD) | A2C59511612 | 13 |

| Diesel common rail pump |       |        |             |            |   |
|-------------------------|-------|--------|-------------|------------|---|
| 1.4 HDi                 | 50 kW | 04/09→ | 8HX (DV4TD) | 5WS40008-Z | 7 |

**CITROËN - C3 I (FC\_) 02/02→**

| Diesel common rail piezo injector |       |        |             |             |    |
|-----------------------------------|-------|--------|-------------|-------------|----|
| 1.4 HDi                           | 50 kW | 02/02→ | 8HX (DV4TD) | A2C59511612 | 13 |

| Diesel common rail pump |       |        |             |            |   |
|-------------------------|-------|--------|-------------|------------|---|
| 1.4 HDi                 | 50 kW | 02/02→ | 8HX (DV4TD) | 5WS40008-Z | 7 |

**CITROËN - C3 II 11/09→**

| Diesel common rail piezo injector |       |        |                           |             |    |
|-----------------------------------|-------|--------|---------------------------|-------------|----|
| 1.4 HDi 70                        | 50 kW | 11/09→ | 8HZ (DV4TD)               | A2C59511612 | 13 |
| 1.6 HDi 110                       | 82 kW | 11/09→ | 9HR (DV6C);  03/10  12/11 | A2C59513556 | 15 |
|                                   |       |        | 9HR (DV6C);  12/11        | A2C59513556 | 15 |
|                                   |       |        | 9HR (DV6C);  12/11        | A2C59513556 | 15 |
| 1.6 HDi 115                       | 84 kW | 09/12→ |                           | A2C59513556 | 15 |

| Diesel common rail pump |       |        |                    |             |    |
|-------------------------|-------|--------|--------------------|-------------|----|
| 1.4 HDi 70              | 50 kW | 11/09→ | 8HZ (DV4TD)        | 5WS40008-Z  | 7  |
| 1.6 HDi 110             | 82 kW | 11/09→ | 9HR (DV6C);  07/10 | A2C59513830 | 16 |
|                         |       |        | 9HR (DV6C);  06/10 | A2C59513830 | 16 |
| 1.6 HDi 115             | 84 kW | 09/12→ | 07/10              | A2C59513830 | 16 |

**CITROËN - C3 Picasso 05/10→**

| Diesel common rail piezo injector |       |        |                           |             |    |
|-----------------------------------|-------|--------|---------------------------|-------------|----|
| 1.6 HDi 110                       | 82 kW | 05/10→ | 9HR (DV6C);  03/10  12/11 | A2C59513556 | 15 |
|                                   |       |        | 9HR (DV6C);  12/11        | A2C59513556 | 15 |
| 1.6 HDi 115                       | 84 kW | 01/13→ | 9HL (DV6C);  12/11        | A2C59513556 | 15 |



VDO

**CITROËN - C3 Picasso 05/10→**

**Diesel common rail pump**

|             |       |        |                    |                    |    |
|-------------|-------|--------|--------------------|--------------------|----|
| 1.6 HDi 110 | 82 kW | 05/10→ | 9HR (DV6C);  07/10 | <b>A2C59513830</b> | 16 |
|             |       |        | 9HR (DV6C);  06/10 | <b>A2C59513830</b> | 16 |
| 1.6 HDi 115 | 84 kW | 01/13→ | 9HL (DV6C);  07/10 | <b>A2C59513830</b> | 16 |

**CITROËN - C3 Pluriel (HB\_) 04/04→**

**Diesel common rail piezo injector**

|         |       |        |             |                   |   |
|---------|-------|--------|-------------|-------------------|---|
| 1.4 HDi | 50 kW | 04/04→ | 8HX (DV4TD) | <b>5WS40148-Z</b> | 7 |
|---------|-------|--------|-------------|-------------------|---|

**Diesel common rail pump**

|         |       |        |             |                   |   |
|---------|-------|--------|-------------|-------------------|---|
| 1.4 HDi | 50 kW | 04/04→ | 8HX (DV4TD) | <b>5WS40008-Z</b> | 7 |
|---------|-------|--------|-------------|-------------------|---|

**CITROËN - C4 I (LC\_) 07/08→07/11**

**Diesel common rail piezo injector**

|         |        |             |                                  |                    |    |
|---------|--------|-------------|----------------------------------|--------------------|----|
| 2.0 HDi | 103 kW | 07/08→07/11 | RHF (DW10BTED4); Version (C2): 4 | <b>5WS40156-4Z</b> | 8  |
|         |        |             |                                  | <b>5WS40156-Z</b>  | 8  |
|         |        |             | RHF (DW10BTED4); Version (C2): 6 | <b>A2C59511601</b> | 11 |

**CITROËN - C4 II (B7) 11/09→**

**Diesel common rail piezo injector**

|             |       |        |                           |                    |    |
|-------------|-------|--------|---------------------------|--------------------|----|
| 1.6 HDi 110 | 82 kW | 11/09→ | 9HR (DV6C);  03/10  12/11 | <b>A2C59513556</b> | 15 |
|             |       |        | 9HR (DV6C);  12/11        | <b>A2C59513556</b> | 15 |
|             |       |        | 9HR (DV6C);  12/11        | <b>A2C59513556</b> | 15 |
| 1.6 HDi 115 | 84 kW | 07/12→ | 9HR (DV6C)                | <b>A2C59513556</b> | 15 |

**Diesel common rail pump**

|             |       |        |                    |                    |    |
|-------------|-------|--------|--------------------|--------------------|----|
| 1.6 HDi 110 | 82 kW | 11/09→ | 9HR (DV6C);  07/10 | <b>A2C59513830</b> | 16 |
| 1.6 HDi 115 | 84 kW | 07/12→ |                    |                    |    |

**CITROËN - C4 AIRCROSS 04/12→**

**Diesel common rail piezo injector**

|                 |       |        |                    |                    |    |
|-----------------|-------|--------|--------------------|--------------------|----|
| 1.6 HDi 115     | 84 kW | 04/12→ | 9HL (DV6C);  12/11 | <b>A2C59513556</b> | 15 |
| 1.6 HDi 115 AWC | 84 kW | 05/12→ |                    |                    |    |

**Diesel common rail pump**

|                 |       |        |                    |                    |    |
|-----------------|-------|--------|--------------------|--------------------|----|
| 1.6 HDi 115     | 84 kW | 04/12→ | 9HL (DV6C);  07/10 | <b>A2C59513830</b> | 16 |
| 1.6 HDi 115 AWC | 84 kW | 05/12→ |                    |                    |    |

**CITROËN - C4 Coupe (LA\_) 07/08→07/11**

**Diesel common rail piezo injector**

|         |        |             |                                  |                    |    |
|---------|--------|-------------|----------------------------------|--------------------|----|
| 2.0 HDi | 103 kW | 07/08→07/11 | RHF (DW10BTED4); Version (C2): 4 | <b>5WS40156-4Z</b> | 8  |
|         |        |             |                                  | <b>5WS40156-Z</b>  | 8  |
|         |        |             | RHF (DW10BTED4); Version (C2): 6 | <b>A2C59511601</b> | 11 |

**CITROËN - C4 Grand Picasso I (UA\_) 10/06→**

**Diesel common rail piezo injector**

|             |        |        |                           |                    |    |
|-------------|--------|--------|---------------------------|--------------------|----|
| 1.6 HDi 110 | 82 kW  | 09/10→ | 9HR (DV6C);  03/10  12/11 | <b>A2C59513556</b> | 15 |
|             |        |        | 9HR (DV6C);  12/11        | <b>A2C59513556</b> | 15 |
| 2.0 HDi 138 | 100 kW | 10/06→ | RHJ (DW10BTED4)           | <b>A2C59513552</b> | 14 |
|             |        |        | RHR (DW10BTED4)           | <b>A2C59513552</b> | 14 |

**Diesel common rail pump**

|             |        |        |                    |                    |    |
|-------------|--------|--------|--------------------|--------------------|----|
| 1.6 HDi 110 | 82 kW  | 09/10→ | 9HR (DV6C);  07/10 | <b>A2C59513830</b> | 16 |
| 2.0 HDi 138 | 100 kW | 10/06→ | RHJ (DW10BTED4)    | <b>5WS40809-Z</b>  | 9  |
|             |        |        | RHR (DW10BTED4)    | <b>5WS40809-Z</b>  | 9  |



VDO

**CITROËN - C4 Picasso I (UD\_) 02/07→08/13**

| Diesel common rail piezo injector |        |             |                             |                    |    |
|-----------------------------------|--------|-------------|-----------------------------|--------------------|----|
| 1.6 HDi 110                       | 82 kW  | 09/10→08/13 | 9HR (DV6C);  03/10 -  12/11 | <b>A2C59513556</b> | 15 |
|                                   |        |             | 9HR (DV6C);  12/11          | <b>A2C59513556</b> | 15 |
| 2.0 HDi 138                       | 100 kW | 02/07→08/13 | RHJ (DW10BTED4)             | <b>A2C59513552</b> | 14 |
|                                   |        |             | RHR (DW10BTED4)             | <b>A2C59513552</b> | 14 |

| Diesel common rail pump |        |             |                    |                    |    |
|-------------------------|--------|-------------|--------------------|--------------------|----|
| 1.6 HDi 110             | 82 kW  | 09/10→08/13 | 9HR (DV6C);  07/10 | <b>A2C59513830</b> | 16 |
| 2.0 HDi 138             | 100 kW | 02/07→08/13 | RHJ (DW10BTED4)    | <b>5WS40809-Z</b>  | 9  |
|                         |        |             | RHR (DW10BTED4)    | <b>5WS40809-Z</b>  | 9  |

**CITROËN - C4 Picasso II 02/13→**

| Diesel common rail piezo injector |       |        |       |                    |    |
|-----------------------------------|-------|--------|-------|--------------------|----|
| 1.6 HDi / BlueHDi 115             | 85 kW | 02/13→ | 12/11 | <b>A2C59513556</b> | 15 |

| Diesel common rail pump |       |        |       |                    |    |
|-------------------------|-------|--------|-------|--------------------|----|
| 1.6 HDi / BlueHDi 115   | 85 kW | 02/13→ | 07/10 | <b>A2C59513830</b> | 16 |

**CITROËN - C5 I (DC\_) 03/01→08/04**

| Diesel common rail piezo injector |       |             |              |                   |   |
|-----------------------------------|-------|-------------|--------------|-------------------|---|
| 2.0 HDi (DCRHYB)                  | 66 kW | 03/01→08/04 | RHY (DW10TD) | <b>5WS40000-Z</b> | 7 |

**CITROËN - C5 I Break (DE\_) 06/01→08/04**

| Diesel common rail piezo injector |       |             |              |                   |   |
|-----------------------------------|-------|-------------|--------------|-------------------|---|
| 2.0 HDi (DERHYB)                  | 66 kW | 06/01→08/04 | RHY (DW10TD) | <b>5WS40000-Z</b> | 7 |

**CITROËN - C5 II (RC\_) 09/04→**

| Diesel common rail piezo injector |        |        |                                  |                    |    |
|-----------------------------------|--------|--------|----------------------------------|--------------------|----|
| 2.0 HDi (RCRHRH)                  | 100 kW | 09/04→ | RHR (DW10BTED4); Version (C2): 4 | <b>5WS40156-4Z</b> | 8  |
|                                   |        |        |                                  | <b>5WS40156-Z</b>  | 8  |
|                                   |        |        | RHR (DW10BTED4); Version (C2): 6 | <b>A2C59511601</b> | 11 |

| Diesel common rail pump |        |        |  |                   |   |
|-------------------------|--------|--------|--|-------------------|---|
| 2.0 HDi (RCRHRH)        | 100 kW | 09/04→ |  | <b>5WS40809-Z</b> | 9 |

**CITROËN - C5 II Break (RE\_) 09/04→**

| Diesel common rail piezo injector |        |        |                                  |                    |    |
|-----------------------------------|--------|--------|----------------------------------|--------------------|----|
| 2.0 HDi (RERHRH)                  | 100 kW | 09/04→ | RHR (DW10BTED4); Version (C2): 4 | <b>5WS40156-4Z</b> | 8  |
|                                   |        |        |                                  | <b>5WS40156-Z</b>  | 8  |
|                                   |        |        | RHR (DW10BTED4); Version (C2): 6 | <b>A2C59511601</b> | 11 |

| Diesel common rail pump |        |        |  |                   |   |
|-------------------------|--------|--------|--|-------------------|---|
| 2.0 HDi (RERHRH)        | 100 kW | 09/04→ |  | <b>5WS40809-Z</b> | 9 |

**CITROËN - C5 III Break (TD\_) 02/08→**

| Diesel common rail piezo injector |        |        |                             |                    |    |
|-----------------------------------|--------|--------|-----------------------------|--------------------|----|
| 1.6 HDi 110                       | 82 kW  | 07/10→ | 9HR (DV6C);  03/10 -  12/11 | <b>A2C59513556</b> | 15 |
|                                   |        |        | 9HR (DV6C);  12/11          | <b>A2C59513556</b> | 15 |
| 1.6 HDi 115                       | 84 kW  | 01/12→ | 9HR (DV6C)                  | <b>A2C59513556</b> | 15 |
| 2.7 HDi                           | 150 kW | 02/08→ | UHZ (DT17BTED4)             | <b>A2C59511316</b> | 10 |
|                                   |        |        | DT17ED4                     | <b>A2C59511316</b> | 10 |

| Diesel common rail pump |        |        |                    |                    |    |
|-------------------------|--------|--------|--------------------|--------------------|----|
| 1.6 HDi 110             | 82 kW  | 07/10→ | 9HR (DV6C);  07/10 | <b>A2C59513830</b> | 16 |
| 1.6 HDi 115             | 84 kW  | 01/12→ |                    |                    |    |
| 2.7 HDi                 | 150 kW | 02/08→ | DT17ED4            | <b>A2C59511314</b> | 10 |
|                         |        |        | UHZ (DT17BTED4)    | <b>A2C59511314</b> | 10 |



VDO

**CITROËN - C5 III Saloon (RD\_) 02/08→**
**Diesel common rail piezo injector**

|             |        |        |                           |                    |    |
|-------------|--------|--------|---------------------------|--------------------|----|
| 1.6 HDi 110 | 82 kW  | 07/10→ | 9HR (DV6C);  03/10  12/11 | <b>A2C59513556</b> | 15 |
|             |        |        | 9HR (DV6C);  12/11        | <b>A2C59513556</b> | 15 |
| 1.6 HDi 115 | 84 kW  | 01/12→ | 9HR (DV6C)                | <b>A2C59513556</b> | 15 |
| 2.7 HDi     | 150 kW | 02/08→ | DT17ED4                   | <b>A2C59511316</b> | 10 |

**Diesel common rail pump**

|             |        |        |                    |                    |    |
|-------------|--------|--------|--------------------|--------------------|----|
| 1.6 HDi 110 | 82 kW  | 07/10→ | 9HR (DV6C);  07/10 | <b>A2C59513830</b> | 16 |
| 1.6 HDi 115 | 84 kW  | 01/12→ |                    |                    |    |
| 2.7 HDi     | 150 kW | 02/08→ | DT17ED4            | <b>A2C59511314</b> | 10 |

**CITROËN - C6 Saloon (TD\_) 09/05→**
**Diesel common rail piezo injector**

|         |        |        |                 |                    |    |
|---------|--------|--------|-----------------|--------------------|----|
| 2.7 HDi | 150 kW | 09/05→ | UHZ (DT17BTED4) | <b>A2C59511316</b> | 10 |
|         |        |        | DT17ED4         | <b>A2C59511316</b> | 10 |

**Diesel common rail pump**

|         |        |        |                 |                    |    |
|---------|--------|--------|-----------------|--------------------|----|
| 2.7 HDi | 150 kW | 09/05→ | DT17ED4         | <b>A2C59511314</b> | 10 |
|         |        |        | UHZ (DT17BTED4) | <b>A2C59511314</b> | 10 |

**CITROËN - C8 (EA\_, EB\_) 02/07→**
**Diesel common rail piezo injector**

|         |       |        |  |                    |    |
|---------|-------|--------|--|--------------------|----|
| 2.0 HDi | 88 kW | 02/07→ |  | <b>A2C59511602</b> | 11 |
|---------|-------|--------|--|--------------------|----|

**Diesel common rail pump**

|         |       |        |  |                   |   |
|---------|-------|--------|--|-------------------|---|
| 2.0 HDi | 88 kW | 02/07→ |  | <b>5WS40809-Z</b> | 9 |
|---------|-------|--------|--|-------------------|---|

**CITROËN - DISPATCH Box 01/07→**
**Diesel common rail piezo injector**

|             |       |        |  |                    |    |
|-------------|-------|--------|--|--------------------|----|
| 2.0 HDi 120 | 88 kW | 01/07→ |  | <b>A2C59511602</b> | 11 |
|-------------|-------|--------|--|--------------------|----|

**Diesel common rail pump**

|             |       |        |  |                   |   |
|-------------|-------|--------|--|-------------------|---|
| 2.0 HDi 120 | 88 kW | 01/07→ |  | <b>5WS40809-Z</b> | 9 |
|-------------|-------|--------|--|-------------------|---|

**CITROËN - DS3 11/09→07/15**
**Diesel common rail piezo injector**

|             |       |             |                           |                    |    |
|-------------|-------|-------------|---------------------------|--------------------|----|
| 1.6 HDi 110 | 82 kW | 11/09→07/15 | 9HR (DV6C);  03/10        | <b>A2C59513556</b> | 15 |
|             |       |             | 9HR (DV6C);  03/10  12/11 | <b>A2C59513556</b> | 15 |
|             |       |             | 9HR (DV6C);  12/11        | <b>A2C59513556</b> | 15 |
|             |       |             | 9HR (DV6C);  12/11        | <b>A2C59513556</b> | 15 |
| 1.6 HDi 115 | 84 kW | 08/12→07/15 | 9HL (DV6C)                | <b>A2C59513556</b> | 15 |

**Diesel common rail pump**

|             |       |             |                    |                    |    |
|-------------|-------|-------------|--------------------|--------------------|----|
| 1.6 HDi 110 | 82 kW | 11/09→07/15 | 9HR (DV6C);  07/10 | <b>A2C59513830</b> | 16 |
|             |       |             | 9HR (DV6C);  06/10 | <b>A2C59513830</b> | 16 |
| 1.6 HDi 115 | 84 kW | 08/12→07/15 | 9HL (DV6C);  07/10 | <b>A2C59513830</b> | 16 |

**CITROËN - DS4 04/11→07/15**
**Diesel common rail piezo injector**

|             |       |             |                           |                    |    |
|-------------|-------|-------------|---------------------------|--------------------|----|
| 1.6 HDi 110 | 82 kW | 04/11→07/15 | 9HR (DV6C);  03/10  12/11 | <b>A2C59513556</b> | 15 |
|             |       |             | 9HR (DV6C);  12/11        | <b>A2C59513556</b> | 15 |
| 1.6 HDi 115 | 84 kW | 08/12→07/15 | 9HL (DV6C)                | <b>A2C59513556</b> | 15 |

**Diesel common rail pump**

|             |       |             |                    |                    |    |
|-------------|-------|-------------|--------------------|--------------------|----|
| 1.6 HDi 110 | 82 kW | 04/11→07/15 | 9HR (DV6C);  07/10 | <b>A2C59513830</b> | 16 |
| 1.6 HDi 115 | 84 kW | 08/12→07/15 | 9HL (DV6C);  07/10 | <b>A2C59513830</b> | 16 |

**CITROËN - DS5 11/11→07/15**

| Diesel common rail piezo injector |       |             |                            |                    |    |
|-----------------------------------|-------|-------------|----------------------------|--------------------|----|
| 1.6 HDi 110                       | 82 kW | 11/11→07/15 | 9HR (DV6C);  03/10 - 12/11 | <b>A2C59513556</b> | 15 |
|                                   |       |             | 9HR (DV6C);  12/11         | <b>A2C59513556</b> | 15 |
| 1.6 HDi 115                       | 84 kW | 06/12→07/15 |                            | <b>A2C59513556</b> | 15 |

| Diesel common rail pump |       |             |                    |                    |    |
|-------------------------|-------|-------------|--------------------|--------------------|----|
| 1.6 HDi 110             | 82 kW | 11/11→07/15 | 9HR (DV6C);  07/10 | <b>A2C59513830</b> | 16 |
| 1.6 HDi 115             | 84 kW | 06/12→07/15 | 07/10              | <b>A2C59513830</b> | 16 |

**CITROËN - JUMPER Box 07/11→**

| Diesel common rail piezo injector |        |        |  |                    |    |
|-----------------------------------|--------|--------|--|--------------------|----|
| 2.2 HDi 110                       | 81 kW  | 07/11→ |  | <b>A2C59517051</b> | 18 |
| 2.2 HDi 130                       | 96 kW  | 07/11→ |  |                    |    |
| 2.2 HDi 150                       | 110 kW | 07/11→ |  |                    |    |

| Diesel common rail pump |        |        |  |                    |    |
|-------------------------|--------|--------|--|--------------------|----|
| 2.2 HDi 110             | 81 kW  | 07/11→ |  | <b>A2C59517045</b> | 17 |
| 2.2 HDi 130             | 96 kW  | 07/11→ |  |                    |    |
| 2.2 HDi 150             | 110 kW | 07/11→ |  |                    |    |

**CITROËN - JUMPER Bus 07/11→**

| Diesel common rail piezo injector |        |        |  |                    |    |
|-----------------------------------|--------|--------|--|--------------------|----|
| 2.2 HDi 110                       | 81 kW  | 07/11→ |  | <b>A2C59517051</b> | 18 |
| 2.2 HDi 130                       | 96 kW  | 07/11→ |  |                    |    |
| 2.2 HDi 150                       | 110 kW | 07/11→ |  |                    |    |

| Diesel common rail pump |        |        |  |                    |    |
|-------------------------|--------|--------|--|--------------------|----|
| 2.2 HDi 110             | 81 kW  | 07/11→ |  | <b>A2C59517045</b> | 17 |
| 2.2 HDi 130             | 96 kW  | 07/11→ |  |                    |    |
| 2.2 HDi 150             | 110 kW | 07/11→ |  |                    |    |

**CITROËN - JUMPER Platform/Chassis 07/11→**

| Diesel common rail piezo injector |        |        |  |                    |    |
|-----------------------------------|--------|--------|--|--------------------|----|
| 2.2 HDi 110                       | 81 kW  | 07/11→ |  | <b>A2C59517051</b> | 18 |
| 2.2 HDi 130                       | 96 kW  | 07/11→ |  |                    |    |
| 2.2 HDi 150                       | 110 kW | 07/11→ |  |                    |    |

| Diesel common rail pump |        |        |  |                    |    |
|-------------------------|--------|--------|--|--------------------|----|
| 2.2 HDi 110             | 81 kW  | 07/11→ |  | <b>A2C59517045</b> | 17 |
| 2.2 HDi 130             | 96 kW  | 07/11→ |  |                    |    |
| 2.2 HDi 150             | 110 kW | 07/11→ |  |                    |    |

**CITROËN - JUMPY 01/07→**

| Diesel common rail piezo injector |       |        |  |                    |    |
|-----------------------------------|-------|--------|--|--------------------|----|
| 2.0 HDi 120                       | 88 kW | 01/07→ |  | <b>A2C59511602</b> | 11 |

| Diesel common rail pump |       |        |  |                   |   |
|-------------------------|-------|--------|--|-------------------|---|
| 2.0 HDi 120             | 88 kW | 01/07→ |  | <b>5WS40809-Z</b> | 9 |

**CITROËN - XSARA (N1) 02/99→03/05**

| Diesel common rail piezo injector |       |             |              |                   |   |
|-----------------------------------|-------|-------------|--------------|-------------------|---|
| 2.0 HDi 90                        | 66 kW | 02/99→03/05 | RHY (DW10TD) | <b>5WS40000-Z</b> | 7 |

**CITROËN - XSARA Break (N2) 02/99→08/05**

| Diesel common rail piezo injector |       |             |              |                   |   |
|-----------------------------------|-------|-------------|--------------|-------------------|---|
| 2.0 HDi 90                        | 66 kW | 02/99→08/05 | RHY (DW10TD) | <b>5WS40000-Z</b> | 7 |

**CITROËN - XSARA Coupe (N0) 02/99→03/05**

| Diesel common rail piezo injector |       |             |              |                   |   |
|-----------------------------------|-------|-------------|--------------|-------------------|---|
| 2.0 HDi 90                        | 66 kW | 02/99→03/05 | RHY (DW10TD) | <b>5WS40000-Z</b> | 7 |



VDO



### DACIA - DUSTER 06/10→



#### Diesel common rail piezo injector

|             |       |        |         |             |    |
|-------------|-------|--------|---------|-------------|----|
| 1.5 dCi     | 79 kW | 06/10→ | K9K 896 | A2C59513484 | 14 |
| 1.5 dCi     | 80 kW | 08/13→ | K9K 856 | A2C59513484 | 14 |
| 1.5 dCi 4x4 | 79 kW | 06/10→ | K9K 898 | A2C59513484 | 14 |
| 1.5 dCi 4x4 | 80 kW | 08/13→ | K9K 858 | A2C59513484 | 14 |
| 1.5 dCi 4x4 | 81 kW | 10/10→ | K9K 898 | A2C59513484 | 14 |



#### Diesel common rail pump

|             |       |        |         |             |    |
|-------------|-------|--------|---------|-------------|----|
| 1.5 dCi     | 79 kW | 06/10→ | K9K 896 | A2C59513595 | 15 |
| 1.5 dCi     | 80 kW | 08/13→ | K9K 856 | A2C59513595 | 15 |
| 1.5 dCi 4x4 | 79 kW | 06/10→ | K9K 898 | A2C59513595 | 15 |
| 1.5 dCi 4x4 | 80 kW | 08/13→ | K9K 858 | A2C59513595 | 15 |
| 1.5 dCi 4x4 | 81 kW | 10/10→ | K9K 898 | A2C59513595 | 15 |

### DACIA - DUSTER Box 04/13→



#### Diesel common rail piezo injector

|             |       |        |         |             |    |
|-------------|-------|--------|---------|-------------|----|
| 1.5 dCi     | 80 kW | 04/13→ | K9K 856 | A2C59513484 | 14 |
| 1.5 dCi 4x4 | 80 kW | 04/13→ | K9K 858 | A2C59513484 | 14 |



#### Diesel common rail pump

|             |       |        |         |             |    |
|-------------|-------|--------|---------|-------------|----|
| 1.5 dCi     | 80 kW | 04/13→ | K9K 856 | A2C59513595 | 15 |
| 1.5 dCi 4x4 | 80 kW | 04/13→ | K9K 858 | A2C59513595 | 15 |

### DACIA - LODGY 01/13→



#### Diesel common rail piezo injector

|         |       |        |         |             |    |
|---------|-------|--------|---------|-------------|----|
| 1.5 dCi | 79 kW | 01/13→ | K9K 846 | A2C59513484 | 14 |
|---------|-------|--------|---------|-------------|----|



#### Diesel common rail pump

|         |       |        |         |             |    |
|---------|-------|--------|---------|-------------|----|
| 1.5 dCi | 79 kW | 01/13→ | K9K 846 | A2C59513595 | 15 |
|---------|-------|--------|---------|-------------|----|

### FIAT - SCUDO (272, 270) 01/07→



#### Diesel common rail piezo injector

|                    |        |        |                      |             |    |
|--------------------|--------|--------|----------------------|-------------|----|
| 2.0 D Multijet     | 88 kW  | 01/07→ | RHK; Version (C2): 4 | 5WS40156-4Z | 8  |
|                    |        |        | RHK                  | A2C59511602 | 11 |
| 2.0 D Multijet     | 100 kW | 01/07→ | RHR; Version (C2): 4 | 5WS40156-4Z | 8  |
|                    |        |        | RHR; Version (C2): 5 | 5WS40156-Z  | 8  |
|                    |        |        | RHR; Version (C2): 6 | A2C59511601 | 11 |
|                    |        |        | RHK; Version (C2): 4 | 5WS40156-4Z | 8  |
| 2.0 D Multijet 4x4 | 88 kW  | 01/07→ | RHK                  | A2C59511602 | 11 |



#### Diesel common rail pump

|                    |        |        |     |            |   |
|--------------------|--------|--------|-----|------------|---|
| 2.0 D Multijet     | 88 kW  | 01/07→ | RHK | 5WS40809-Z | 9 |
| 2.0 D Multijet     | 100 kW | 01/07→ | RHR | 5WS40809-Z | 9 |
| 2.0 D Multijet 4x4 | 88 kW  | 01/07→ | RHK | 5WS40809-Z | 9 |

### FIAT - SCUDO Box (272, 270) 01/07→



#### Diesel common rail piezo injector

|                    |        |        |                      |             |    |
|--------------------|--------|--------|----------------------|-------------|----|
| 2.0 D Multijet     | 88 kW  | 01/07→ | RHK; Version (C2): 4 | 5WS40156-4Z | 8  |
|                    |        |        | RHK                  | A2C59511602 | 11 |
| 2.0 D Multijet     | 100 kW | 01/07→ | RHR; Version (C2): 4 | 5WS40156-4Z | 8  |
|                    |        |        | RHR; Version (C2): 5 | 5WS40156-Z  | 8  |
|                    |        |        | RHR; Version (C2): 6 | A2C59511601 | 11 |
|                    |        |        | RHK; Version (C2): 4 | 5WS40156-4Z | 8  |
| 2.0 D Multijet 4x4 | 88 kW  | 01/07→ | RHK                  | A2C59511602 | 11 |



#### Diesel common rail pump

|                    |        |        |     |            |   |
|--------------------|--------|--------|-----|------------|---|
| 2.0 D Multijet     | 88 kW  | 01/07→ | RHK | 5WS40809-Z | 9 |
| 2.0 D Multijet     | 100 kW | 01/07→ | RHR | 5WS40809-Z | 9 |
| 2.0 D Multijet 4x4 | 88 kW  | 01/07→ | RHK | 5WS40809-Z | 9 |



VDO

**FIAT - SCUDO Platform/Chassis (272, 270) 01/07→** **Diesel common rail piezo injector**

|                |        |        |                                  |                    |    |
|----------------|--------|--------|----------------------------------|--------------------|----|
| 2.0 D Multijet | 88 kW  | 01/07→ | RHK; Version (C2): 4             | <b>5WS40156-4Z</b> | 8  |
|                |        |        | RHK                              | <b>A2C59511602</b> | 11 |
| 2.0 D Multijet | 100 kW | 01/07→ | RHR / DW10BTED4; Version (C2): 4 | <b>5WS40156-4Z</b> | 8  |
|                |        |        | DW10BTED4                        | <b>5WS40156-Z</b>  | 8  |
|                |        |        | RHR                              | <b>5WS40156-Z</b>  | 8  |
|                |        |        | RHR / DW10BTED4; Version (C2): 6 | <b>A2C59511601</b> | 11 |

**Diesel common rail pump**

|                |        |        |           |                   |   |
|----------------|--------|--------|-----------|-------------------|---|
| 2.0 D Multijet | 88 kW  | 01/07→ | RHK       | <b>5WS40809-Z</b> | 9 |
| 2.0 D Multijet | 100 kW | 01/07→ | RHR       | <b>5WS40809-Z</b> | 9 |
|                |        |        | DW10BTED4 | <b>5WS40809-Z</b> | 9 |

**FIAT - ULYSSE (179AX) 05/06→06/11** **Diesel common rail piezo injector**

|                |        |             |                      |                    |    |
|----------------|--------|-------------|----------------------|--------------------|----|
| 2.0 D Multijet | 88 kW  | 05/06→06/11 | RHK; Version (C2): 4 | <b>5WS40156-4Z</b> | 8  |
|                |        |             | RHK                  | <b>A2C59511602</b> | 11 |
| 2.0 D Multijet | 100 kW | 05/06→06/11 | RHR; Version (C2): 4 | <b>5WS40156-4Z</b> | 8  |
|                |        |             | RHR; Version (C2): 5 | <b>5WS40156-Z</b>  | 8  |
|                |        |             | RHR; Version (C2): 6 | <b>A2C59511601</b> | 11 |

**Diesel common rail pump**

|                |        |             |     |                   |   |
|----------------|--------|-------------|-----|-------------------|---|
| 2.0 D Multijet | 88 kW  | 05/06→06/11 | RHK | <b>5WS40809-Z</b> | 9 |
| 2.0 D Multijet | 100 kW | 05/06→06/11 | RHR | <b>5WS40809-Z</b> | 9 |

**FORD - C-MAX (DM2) 02/07→09/10** **Diesel common rail piezo injector**

|          |        |             |  |                    |    |
|----------|--------|-------------|--|--------------------|----|
| 1.8 TDCi | 85 kW  | 02/07→09/10 | KKDA                                       | <b>A2C59511610</b> | 12 |
| 2.0 TDCi | 100 kW | 02/07→09/10 | G6DA / G6DB / G6DD / G6DG; Version (C2): 4 | <b>5WS40156-4Z</b> | 8  |
|          |        |             | G6DA / G6DB / G6DD / G6DG; Version (C2): 5 | <b>5WS40156-Z</b>  | 8  |
|          |        |             | G6DA / G6DB / G6DD / G6DG; Version (C2): 6 | <b>A2C59511601</b> | 11 |

**Diesel common rail pump**

|          |        |             |      |                    |    |
|----------|--------|-------------|------|--------------------|----|
| 1.8 TDCi | 85 kW  | 02/07→09/10 | KKDA | <b>A2C59511609</b> | 12 |
| 2.0 TDCi | 100 kW | 02/07→09/10 | G6DB | <b>A2C59511600</b> | 11 |
|          |        |             | G6DD | <b>A2C59511600</b> | 11 |
|          |        |             | G6DG | <b>A2C59511600</b> | 11 |
|          |        |             | G6DA | <b>A2C59511600</b> | 11 |

**FORD - C-MAX II (DXA/CB7, DXA/CEU) 12/10→** **Diesel common rail piezo injector**

|          |       |        |      |                    |    |
|----------|-------|--------|------|--------------------|----|
| 1.6 TDCi | 70 kW | 12/10→ | T3DA | <b>A2C59513556</b> | 15 |
|          |       |        | T3DB | <b>A2C59513556</b> | 15 |
| 1.6 TDCi | 85 kW | 12/10→ | T1DB | <b>A2C59513556</b> | 15 |
|          |       |        | T1DA | <b>A2C59513556</b> | 15 |

**Diesel common rail pump**

|          |       |        |      |                    |    |
|----------|-------|--------|------|--------------------|----|
| 1.6 TDCi | 70 kW | 12/10→ | T3DA | <b>A2C59513829</b> | 16 |
|          |       |        | T3DB | <b>A2C59513829</b> | 16 |
| 1.6 TDCi | 85 kW | 12/10→ | T1DA | <b>A2C59513829</b> | 16 |
|          |       |        | T1DB | <b>A2C59513829</b> | 16 |

**FORD - FIESTA V (JH\_, JD\_) 11/01→06/08** **Diesel common rail piezo injector**

|          |       |             |      |                    |    |
|----------|-------|-------------|------|--------------------|----|
| 1.4 TDCi | 50 kW | 11/01→06/08 | F6JA | <b>A2C59511612</b> | 13 |
|----------|-------|-------------|------|--------------------|----|

**Diesel common rail pump**

|          |       |             |      |                   |   |
|----------|-------|-------------|------|-------------------|---|
| 1.4 TDCi | 50 kW | 11/01→06/08 | F6JA | <b>5WS40008-Z</b> | 7 |
|----------|-------|-------------|------|-------------------|---|





|   |  |             |  |   |  | VDO         |    |
|---|--|-------------|--|---|--|-------------|----|
| <b>FORD - FIESTA V Van 10/03→12/10</b>          |  |             |  |   |  |             |    |
|   | <b>Diesel common rail piezo injector</b> |             |  |   |  |             |    |
| 1.4 TDCi  | 50 kW                                    | 10/03→12/10 |  | F6JB  |  | A2C59511612 | 13 |
|   | <b>Diesel common rail pump</b>           |             |  |   |  |             |    |
| 1.4 TDCi  | 50 kW                                    | 10/03→12/10 |  | F6JB  |  | 5WS40008-Z  | 7  |
| <b>FORD - FIESTA VI 01/09→</b>                  |  |             |  |   |  |             |    |
|   | <b>Diesel common rail piezo injector</b> |             |  |   |  |             |    |
| 1.4 TDCi  | 50 kW                                    | 01/09→      |  | F6JB  |  | A2C59511612 | 13 |
|   | <b>Diesel common rail pump</b>           |             |  |   |  |             |    |
| 1.4 TDCi  | 50 kW                                    | 01/09→      |  | F6JB  |  | 5WS40008-Z  | 7  |
| 1.4 TDCi  | 51 kW                                    | 07/10→      |  | KVJA  |  | 5WS40008-Z  | 7  |
| <b>FORD - FIESTA VI Van 01/09→</b>              |  |             |  |   |  |             |    |
|   | <b>Diesel common rail piezo injector</b> |             |  |   |  |             |    |
| 1.4 TDCi  | 50 kW                                    | 01/09→      |  | F6JB  |  | A2C59511612 | 13 |
|   | <b>Diesel common rail pump</b>           |             |  |   |  |             |    |
| 1.4 TDCi  | 50 kW                                    | 01/09→      |  | F6JB  |  | 5WS40008-Z  | 7  |
| 1.4 TDCi  | 51 kW                                    | 07/10→      |  | F6JD  |  | 5WS40008-Z  | 7  |
| <b>FORD - FOCUS (DAW, DBW) 08/02→11/04</b>      |  |             |  |   |  |             |    |
|   | <b>Diesel common rail piezo injector</b> |             |  |   |  |             |    |
| 1.8 TDCi  | 74 kW                                    | 08/02→11/04 |  | FFDA  |  | A2C59511610 | 12 |
|   | <b>Diesel common rail pump</b>           |             |  |   |  |             |    |
| 1.8 TDCi  | 74 kW                                    | 08/02→11/04 |  | FFDA  |  | A2C59511609 | 12 |
| <b>FORD - FOCUS II (DA_) 07/04→09/12</b>        |  |             |  |   |  |             |    |
|   | <b>Diesel common rail piezo injector</b> |             |  |   |  |             |    |
| 1.8 TDCi  | 85 kW                                    | 01/05→09/12 |  | KKDA  |  | A2C59511610 | 12 |
|   |  |             |  | KKDB  |  | A2C59511610 | 12 |
| 2.0 TDCi  | 100 kW                                   | 07/04→09/12 |  | G6DA / G6DB; Version (C2): 4                    |  | 5WS40156-4Z | 8  |
|   |  |             |  | G6DA / G6DB; Version (C2): 5                    |  | 5WS40156-Z  | 8  |
|   |  |             |  | G6DA / G6DB; Version (C2): 6                    |  | A2C59511601 | 11 |
|   | <b>Diesel common rail pump</b>           |             |  |   |  |             |    |
| 1.8 TDCi  | 85 kW                                    | 01/05→09/12 |  | KKDB  |  | A2C59511609 | 12 |
|   |  |             |  | KKDA  |  | A2C59511609 | 12 |
| 2.0 TDCi  | 100 kW                                   | 07/04→09/12 |  | G6DA;  10/06                                    |  | 5WS40809-Z  | 9  |
|   |  |             |  | G6DB;  10/06                                    |  | 5WS40809-Z  | 9  |
|   |  |             |  | G6DA;  11/06 ; Specification (C3): Eurocode 223 |  | A2C59511600 | 11 |
|   |  |             |  | G6DB;  11/06 ; Specification (C3): Eurocode 223 |  | A2C59511600 | 11 |
| <b>FORD - FOCUS II Convertible 10/06→07/11</b>  |  |             |  |   |  |             |    |
|   | <b>Diesel common rail piezo injector</b> |             |  |   |  |             |    |
| 2.0 TDCi  | 100 kW                                   | 10/06→07/11 |  | G6DA; Version (C2): 4                           |  | 5WS40156-4Z | 8  |
|   |  |             |  | G6DA; Version (C2): 5                           |  | 5WS40156-Z  | 8  |
|   |  |             |  | G6DA; Version (C2): 6                           |  | A2C59511601 | 11 |
|   | <b>Diesel common rail pump</b>           |             |  |   |  |             |    |
| 2.0 TDCi  | 100 kW                                   | 10/06→07/11 |  | G6DA  |  | 5WS40809-Z  | 9  |
|   |  |             |  | G6DA; Specification (C3): Eurocode 223          |  | A2C59511600 | 11 |
| <b>FORD - FOCUS II Estate (DA_) 07/04→09/12</b> |  |             |  |   |  |             |    |
|   | <b>Diesel common rail piezo injector</b> |             |  |   |  |             |    |
| 1.8 TDCi  | 85 kW                                    | 07/04→09/12 |  | KKDA  |  | A2C59511610 | 12 |
|   |  |             |  | KKDB  |  | A2C59511610 | 12 |

**FORD - FOCUS II Estate (DA\_) 07/04→09/12**

| Diesel common rail piezo injector |        |             |                              |                    |    |
|-----------------------------------|--------|-------------|------------------------------|--------------------|----|
| 2.0 TDCi                          | 100 kW | 07/04→09/12 | G6DA / G6DB; Version (C2): 4 | <b>5WS40156-4Z</b> | 8  |
|                                   |        |             | G6DA / G6DB; Version (C2): 5 | <b>5WS40156-Z</b>  | 8  |
|                                   |        |             | G6DA                         | <b>A2C59511601</b> | 11 |

| Diesel common rail pump |        |             |   |                    |    |
|-------------------------|--------|-------------|---|--------------------|----|
| 1.8 TDCi                | 85 kW  | 07/04→09/12 | KKDB  | <b>A2C59511609</b> | 12 |
|                         |        |             | KKDA  | <b>A2C59511609</b> | 12 |
| 2.0 TDCi                | 100 kW | 07/04→09/12 | G6DA;  10/06                                    | <b>5WS40809-Z</b>  | 9  |
|                         |        |             | G6DB;  10/06                                    | <b>5WS40809-Z</b>  | 9  |
|                         |        |             | G6DA;  11/06 ; Specification (C3): Eurocode 223 | <b>A2C59511600</b> | 11 |
|                         |        |             | G6DB;  11/06 ; Specification (C3): Eurocode 223 | <b>A2C59511600</b> | 11 |

**FORD - FOCUS II Saloon (DA\_) 04/05→09/12**

| Diesel common rail piezo injector |        |             |                       |                    |    |
|-----------------------------------|--------|-------------|-----------------------|--------------------|----|
| 1.8 TDCi                          | 85 kW  | 04/05→09/12 | KKDA                  | <b>A2C59511610</b> | 12 |
|                                   |        |             | KKDB                  | <b>A2C59511610</b> | 12 |
| 2.0 TDCi                          | 100 kW | 04/05→09/12 | G6DB; Version (C2): 4 | <b>5WS40156-4Z</b> | 8  |
|                                   |        |             | G6DB; Version (C2): 5 | <b>5WS40156-Z</b>  | 8  |
|                                   |        |             | G6DB; Version (C2): 6 | <b>A2C59511601</b> | 11 |

| Diesel common rail pump |        |             |   |                    |    |
|-------------------------|--------|-------------|---|--------------------|----|
| 1.8 TDCi                | 85 kW  | 04/05→09/12 | KKDB  | <b>A2C59511609</b> | 12 |
|                         |        |             | KKDA  | <b>A2C59511609</b> | 12 |
| 2.0 TDCi                | 100 kW | 04/05→09/12 | G6DB;  10/06                                    | <b>5WS40809-Z</b>  | 9  |
|                         |        |             | G6DB;  11/06 ; Specification (C3): Eurocode 223 | <b>A2C59511600</b> | 11 |

**FORD - FOCUS III 07/10→**

| Diesel common rail piezo injector |       |        |      |                    |    |
|-----------------------------------|-------|--------|------|--------------------|----|
| 1.6 TDCi                          | 70 kW | 07/10→ | T3DA | <b>A2C59513556</b> | 15 |
|                                   |       |        | T3DB | <b>A2C59513556</b> | 15 |
| 1.6 TDCi                          | 85 kW | 07/10→ | T1DB | <b>A2C59513556</b> | 15 |
|                                   |       |        | T1DA | <b>A2C59513556</b> | 15 |
| 1.6 TDCi ECOnetic                 | 77 kW | 05/12→ | NGDA | <b>A2C59513556</b> | 15 |

| Diesel common rail pump |       |        |      |                    |    |
|-------------------------|-------|--------|------|--------------------|----|
| 1.6 TDCi                | 70 kW | 07/10→ | T3DA | <b>A2C59513829</b> | 16 |
|                         |       |        | T3DB | <b>A2C59513829</b> | 16 |
| 1.6 TDCi                | 85 kW | 07/10→ | T1DA | <b>A2C59513829</b> | 16 |
|                         |       |        | T1DB | <b>A2C59513829</b> | 16 |
| 1.6 TDCi ECOnetic       | 77 kW | 05/12→ | NGDA | <b>A2C59513829</b> | 16 |

**FORD - FOCUS III Saloon 07/10→**

| Diesel common rail piezo injector |       |        |      |                    |    |
|-----------------------------------|-------|--------|------|--------------------|----|
| 1.6 TDCi                          | 70 kW | 07/10→ | T3DA | <b>A2C59513556</b> | 15 |
|                                   |       |        | T3DB | <b>A2C59513556</b> | 15 |
| 1.6 TDCi                          | 85 kW | 07/10→ | T1DB | <b>A2C59513556</b> | 15 |
|                                   |       |        | T1DA | <b>A2C59513556</b> | 15 |

| Diesel common rail pump |       |        |      |                    |    |
|-------------------------|-------|--------|------|--------------------|----|
| 1.6 TDCi                | 70 kW | 07/10→ | T3DA | <b>A2C59513829</b> | 16 |
|                         |       |        | T3DB | <b>A2C59513829</b> | 16 |
| 1.6 TDCi                | 85 kW | 07/10→ | T1DA | <b>A2C59513829</b> | 16 |
|                         |       |        | T1DB | <b>A2C59513829</b> | 16 |

**FORD - FOCUS III Turnier 07/10→**

| Diesel common rail piezo injector |       |        |      |                    |    |
|-----------------------------------|-------|--------|------|--------------------|----|
| 1.6 TDCi                          | 70 kW | 07/10→ | T3DA | <b>A2C59513556</b> | 15 |
|                                   |       |        | T3DB | <b>A2C59513556</b> | 15 |



VDO

**FORD - FOCUS III Turnier 07/10→**
**Diesel common rail piezo injector**

|                   |       |        |      |                    |    |
|-------------------|-------|--------|------|--------------------|----|
| 1.6 TDCi          | 85 kW | 07/10→ | T1DB | <b>A2C59513556</b> | 15 |
|                   |       |        | T1DA | <b>A2C59513556</b> | 15 |
| 1.6 TDCi ECONetic | 77 kW | 05/12→ | NGDA | <b>A2C59513556</b> | 15 |

**Diesel common rail pump**

|                   |       |        |      |                    |    |
|-------------------|-------|--------|------|--------------------|----|
| 1.6 TDCi          | 70 kW | 07/10→ | T3DA | <b>A2C59513829</b> | 16 |
|                   |       |        | T3DB | <b>A2C59513829</b> | 16 |
| 1.6 TDCi          | 85 kW | 07/10→ | T1DA | <b>A2C59513829</b> | 16 |
|                   |       |        | T1DB | <b>A2C59513829</b> | 16 |
| 1.6 TDCi ECONetic | 77 kW | 05/12→ | NGDA | <b>A2C59513829</b> | 16 |

**FORD - FOCUS C-MAX 10/03→03/07**
**Diesel common rail piezo injector**

|          |        |             |  |                    |    |
|----------|--------|-------------|--|--------------------|----|
| 1.8 TDCi | 85 kW  | 01/05→03/07 | KKDA                                       | <b>A2C59511610</b> | 12 |
| 2.0 TDCi | 100 kW | 10/03→03/07 | G6DA / G6DB / G6DD / G6DG; Version (C2): 4 | <b>5WS40156-4Z</b> | 8  |
|          |        |             | G6DA / G6DB / G6DD / G6DG; Version (C2): 5 | <b>5WS40156-Z</b>  | 8  |
|          |        |             | G6DA / G6DB / G6DD / G6DG; Version (C2): 6 | <b>A2C59511601</b> | 11 |

**Diesel common rail pump**

|          |        |             |   |                    |    |
|----------|--------|-------------|---|--------------------|----|
| 1.8 TDCi | 85 kW  | 01/05→03/07 | KKDA  | <b>A2C59511609</b> | 12 |
| 2.0 TDCi | 100 kW | 10/03→03/07 | G6DB;  10/06                                    | <b>5WS40809-Z</b>  | 9  |
|          |        |             | G6DA;  10/06                                    | <b>5WS40809-Z</b>  | 9  |
|          |        |             | G6DG;  10/06                                    | <b>5WS40809-Z</b>  | 9  |
|          |        |             | G6DD;  10/06                                    | <b>5WS40809-Z</b>  | 9  |
|          |        |             | G6DA;  11/06 ; Specification (C3): Eurocode 223 | <b>A2C59511600</b> | 11 |
|          |        |             | G6DD;  11/06 ; Specification (C3): Eurocode 223 | <b>A2C59511600</b> | 11 |
|          |        |             | G6DG;  11/06 ; Specification (C3): Eurocode 223 | <b>A2C59511600</b> | 11 |
|          |        |             | G6DB;  11/06 ; Specification (C3): Eurocode 223 | <b>A2C59511600</b> | 11 |

**FORD - FOCUS Estate (DNW) 08/02→11/04**
**Diesel common rail piezo injector**

|          |       |             |      |                    |    |
|----------|-------|-------------|------|--------------------|----|
| 1.8 TDCi | 74 kW | 08/02→11/04 | FFDA | <b>A2C59511610</b> | 12 |
|----------|-------|-------------|------|--------------------|----|

**Diesel common rail pump**

|          |       |             |      |                    |    |
|----------|-------|-------------|------|--------------------|----|
| 1.8 TDCi | 74 kW | 08/02→11/04 | FFDA | <b>A2C59511609</b> | 12 |
|----------|-------|-------------|------|--------------------|----|

**FORD - FOCUS Saloon (DFW) 08/02→11/04**
**Diesel common rail piezo injector**

|          |       |             |      |                    |    |
|----------|-------|-------------|------|--------------------|----|
| 1.8 TDCi | 74 kW | 08/02→11/04 | FFDA | <b>A2C59511610</b> | 12 |
|----------|-------|-------------|------|--------------------|----|

**Diesel common rail pump**

|          |       |             |      |                    |    |
|----------|-------|-------------|------|--------------------|----|
| 1.8 TDCi | 74 kW | 08/02→11/04 | FFDA | <b>A2C59511609</b> | 12 |
|----------|-------|-------------|------|--------------------|----|

**FORD - FUSION (JU\_) 08/02→07/05**
**Diesel common rail piezo injector**

|          |       |             |      |                    |    |
|----------|-------|-------------|------|--------------------|----|
| 1.4 TDCi | 50 kW | 08/02→07/05 | F6JA | <b>5WS40148-Z</b>  | 7  |
|          |       |             | F6JB | <b>A2C59511612</b> | 13 |

**Diesel common rail pump**

|          |       |             |      |                   |   |
|----------|-------|-------------|------|-------------------|---|
| 1.4 TDCi | 50 kW | 08/02→07/05 | F6JB | <b>5WS40008-Z</b> | 7 |
|          |       |             | F6JA | <b>5WS40008-Z</b> | 7 |

**FORD - GALAXY (WA6) 05/06→06/15**
**Diesel common rail piezo injector**

|          |       |             |      |                    |    |
|----------|-------|-------------|------|--------------------|----|
| 1.6 TDCi | 85 kW | 02/11→06/15 |      | <b>A2C59513556</b> | 15 |
| 1.8 TDCi | 74 kW | 05/06→06/15 | FFWA | <b>A2C59511610</b> | 12 |
| 1.8 TDCi | 92 kW | 05/06→06/15 | QYWA | <b>A2C59511610</b> | 12 |

**FORD - GALAXY (WA6) 05/06→06/15** **Diesel common rail piezo injector**

|          |        |             |  |                    |    |
|----------|--------|-------------|--|--------------------|----|
| 2.0 TDCi | 100 kW | 05/06→06/15 | UKWA / AZWC                                | <b>5WS40156-4Z</b> | 8  |
|          |        |             | AZWC / UKWA; Version (C2): 5               | <b>5WS40156-Z</b>  | 8  |
|          |        |             | AZWC / UKWA; Version (C2): 6               | <b>A2C59511601</b> | 11 |
| 2.0 TDCi | 103 kW | 05/06→06/15 | QXWA / QXWB / QXWC / UFWA; Version (C2): 4 | <b>5WS40156-4Z</b> | 8  |
|          |        |             | QXWA / QXWB / QXWC / UFWA; Version (C2): 5 | <b>5WS40156-Z</b>  | 8  |
|          |        |             | QXWA / QXWB / QXWC / UFWA; Version (C2): 6 | <b>A2C59511601</b> | 11 |

**Diesel common rail pump**

|          |        |             |      |                    |    |
|----------|--------|-------------|------|--------------------|----|
| 1.6 TDCi | 85 kW  | 02/11→06/15 |      | <b>A2C59513829</b> | 16 |
| 1.8 TDCi | 74 kW  | 05/06→06/15 | FFWA | <b>A2C59511609</b> | 12 |
| 1.8 TDCi | 92 kW  | 05/06→06/15 | QYWA | <b>A2C59511609</b> | 12 |
| 2.0 TDCi | 100 kW | 05/06→06/15 | UKWA | <b>A2C59511600</b> | 11 |
|          |        |             | AZWC | <b>A2C59511600</b> | 11 |
| 2.0 TDCi | 103 kW | 05/06→06/15 | QXWA | <b>A2C59511600</b> | 11 |
|          |        |             | UFWA | <b>A2C59511600</b> | 11 |
|          |        |             | QXWC | <b>A2C59511600</b> | 11 |
|          |        |             | QXWB | <b>A2C59511600</b> | 11 |

**FORD - GRAND C-MAX (DXA/CB7, DXA/CEU) 12/10→** **Diesel common rail piezo injector**

|          |       |        |      |                    |    |
|----------|-------|--------|------|--------------------|----|
| 1.6 TDCi | 70 kW | 12/10→ | T3DA | <b>A2C59513556</b> | 15 |
|          |       |        | T3DB | <b>A2C59513556</b> | 15 |
| 1.6 TDCi | 85 kW | 12/10→ | T1DB | <b>A2C59513556</b> | 15 |
|          |       |        | T1DA | <b>A2C59513556</b> | 15 |

**Diesel common rail pump**

|          |       |        |      |                    |    |
|----------|-------|--------|------|--------------------|----|
| 1.6 TDCi | 70 kW | 12/10→ | T3DA | <b>A2C59513829</b> | 16 |
|          |       |        | T3DB | <b>A2C59513829</b> | 16 |
| 1.6 TDCi | 85 kW | 12/10→ | T1DA | <b>A2C59513829</b> | 16 |
|          |       |        | T1DB | <b>A2C59513829</b> | 16 |

**FORD - KUGA I 03/08→11/12** **Diesel common rail piezo injector**

|              |        |             |                              |                    |    |
|--------------|--------|-------------|------------------------------|--------------------|----|
| 2.0 TDCi     | 100 kW | 03/08→11/12 | UKDA / G6DG; Version (C2): 4 | <b>5WS40156-4Z</b> | 8  |
|              |        |             | UKDA / G6DG; Version (C2): 5 | <b>5WS40156-Z</b>  | 8  |
|              |        |             | UKDA / G6DG; Version (C2): 6 | <b>A2C59511601</b> | 11 |
| 2.0 TDCi     | 103 kW | 03/10→11/12 | UFDA; Version (C2): 4        | <b>5WS40156-4Z</b> | 8  |
|              |        |             | UFDA; Version (C2): 5        | <b>5WS40156-Z</b>  | 8  |
|              |        |             | UFDA; Version (C2): 6        | <b>A2C59511601</b> | 11 |
| 2.0 TDCi 4x4 | 100 kW | 03/08→11/12 | G6DG / UKDA; Version (C2): 4 | <b>5WS40156-4Z</b> | 8  |
|              |        |             | UKDA / G6DG                  | <b>5WS40156-Z</b>  | 8  |
|              |        |             | G6DG / UKDA; Version (C2): 6 | <b>A2C59511601</b> | 11 |
| 2.0 TDCi 4x4 | 103 kW | 03/10→11/12 | UFDA; Version (C2): 4        | <b>5WS40156-4Z</b> | 8  |
|              |        |             | UFDA; Version (C2): 5        | <b>5WS40156-Z</b>  | 8  |
|              |        |             | UFDA; Version (C2): 6        | <b>A2C59511601</b> | 11 |

**Diesel common rail pump**

|              |        |             |      |                    |    |
|--------------|--------|-------------|------|--------------------|----|
| 2.0 TDCi     | 100 kW | 03/08→11/12 | G6DG | <b>A2C59511600</b> | 11 |
|              |        |             | UKDA | <b>A2C59511600</b> | 11 |
| 2.0 TDCi     | 103 kW | 03/10→11/12 | UFDA | <b>A2C59511600</b> | 11 |
| 2.0 TDCi 4x4 | 100 kW | 03/08→11/12 | G6DG | <b>A2C59511600</b> | 11 |
|              |        |             | UKDA | <b>A2C59511600</b> | 11 |
| 2.0 TDCi 4x4 | 103 kW | 03/10→11/12 | UFDA | <b>A2C59511600</b> | 11 |

**FORD - MONDEO IV (BA7) 03/07→09/14** **Diesel common rail piezo injector**

|          |       |             |      |                    |    |
|----------|-------|-------------|------|--------------------|----|
| 1.6 TDCi | 85 kW | 02/11→09/14 | T1BB | <b>A2C59513556</b> | 15 |
| 1.8 TDCi | 74 kW | 03/07→09/14 | FFBA | <b>A2C59511610</b> | 12 |



VDO

**FORD - MONDEO IV (BA7) 03/07→09/14**

**Diesel common rail piezo injector**

|          |        |             |                                     |             |    |
|----------|--------|-------------|-------------------------------------|-------------|----|
| 1.8 TDCi | 92 kW  | 06/07→      | KHBA                                | A2C59511610 | 12 |
|          |        |             | QYBA                                | A2C59511610 | 12 |
| 2.0 TDCi | 100 kW | 03/07→09/14 | UKBA / AZBC                         | 5WS40156-4Z | 8  |
|          |        |             | AZBC / UKBA; Version (C2): 5        | 5WS40156-Z  | 8  |
|          |        |             | AZBC / UKBA; Version (C2): 6        | A2C59511601 | 11 |
| 2.0 TDCi | 103 kW | 03/07→09/14 | QXBA / QXBB / UFBA; Version (C2): 4 | 5WS40156-4Z | 8  |
|          |        |             | QXBA / QXBB / UFBA; Version (C2): 5 | 5WS40156-Z  | 8  |
|          |        |             | QXBA / QXBB / UFBA; Version (C2): 6 | A2C59511601 | 11 |

**Diesel common rail pump**

|          |        |             |      |             |    |
|----------|--------|-------------|------|-------------|----|
| 1.6 TDCi | 85 kW  | 02/11→09/14 | T1BB | A2C59513829 | 16 |
| 1.8 TDCi | 74 kW  | 03/07→09/14 | FFBA | A2C59511609 | 12 |
| 1.8 TDCi | 92 kW  | 06/07→      | QYBA | A2C59511609 | 12 |
|          |        |             | KHBA | A2C59511609 | 12 |
| 2.0 TDCi | 100 kW | 03/07→09/14 | UKBA | A2C59511600 | 11 |
|          |        |             | AZBC | A2C59511600 | 11 |
| 2.0 TDCi | 103 kW | 03/07→09/14 | UFBA | A2C59511600 | 11 |
|          |        |             | QXBA | A2C59511600 | 11 |
|          |        |             | QXBB | A2C59511600 | 11 |

**FORD - MONDEO IV Saloon (BA7) 03/07→09/14**

**Diesel common rail piezo injector**

|          |        |             |                                     |             |    |
|----------|--------|-------------|-------------------------------------|-------------|----|
| 1.8 TDCi | 74 kW  | 03/07→09/14 | FFBA                                | A2C59511610 | 12 |
| 1.8 TDCi | 92 kW  | 06/07→09/14 | KHBA                                | A2C59511610 | 12 |
|          |        |             | QYBA                                | A2C59511610 | 12 |
| 2.0 TDCi | 103 kW | 03/07→09/14 | UFBA / QXBA / QXBB                  | 5WS40156-4Z | 8  |
|          |        |             | QXBA / QXBB / UFBA; Version (C2): 5 | 5WS40156-Z  | 8  |
|          |        |             | QXBA / QXBB / UFBA; Version (C2): 6 | A2C59511601 | 11 |

**Diesel common rail pump**

|          |        |             |      |             |    |
|----------|--------|-------------|------|-------------|----|
| 1.8 TDCi | 74 kW  | 03/07→09/14 | FFBA | A2C59511609 | 12 |
| 1.8 TDCi | 92 kW  | 06/07→09/14 | QYBA | A2C59511609 | 12 |
|          |        |             | KHBA | A2C59511609 | 12 |
| 2.0 TDCi | 103 kW | 03/07→09/14 | UFBA | A2C59511600 | 11 |
|          |        |             | QXBA | A2C59511600 | 11 |
|          |        |             | QXBB | A2C59511600 | 11 |

**FORD - MONDEO IV Turnier (BA7) 03/07→09/14**

**Diesel common rail piezo injector**

|          |        |             |                                     |             |    |
|----------|--------|-------------|-------------------------------------|-------------|----|
| 1.6 TDCi | 85 kW  | 02/11→09/14 | T1BB                                | A2C59513556 | 15 |
| 1.8 TDCi | 74 kW  | 03/07→12/12 | FFBA                                | A2C59511610 | 12 |
| 1.8 TDCi | 92 kW  | 06/07→12/12 | KHBA                                | A2C59511610 | 12 |
|          |        |             | QYBA                                | A2C59511610 | 12 |
| 2.0 TDCi | 100 kW | 03/07→09/14 | UKBA / AZBC; Version (C2): 4        | 5WS40156-4Z | 8  |
|          |        |             | UKBA / AZBC; Version (C2): 5        | 5WS40156-Z  | 8  |
|          |        |             | UKBA / AZBC; Version (C2): 6        | A2C59511601 | 11 |
| 2.0 TDCi | 103 kW | 03/07→09/14 | QXBA / QXBB / UFBA; Version (C2): 4 | 5WS40156-4Z | 8  |
|          |        |             | QXBA / QXBB / UFBA; Version (C2): 5 | 5WS40156-Z  | 8  |
|          |        |             | QXBA / QXBB / UFBA; Version (C2): 6 | A2C59511601 | 11 |

**Diesel common rail pump**

|          |        |             |      |             |    |
|----------|--------|-------------|------|-------------|----|
| 1.6 TDCi | 85 kW  | 02/11→09/14 | T1BB | A2C59513829 | 16 |
| 1.8 TDCi | 74 kW  | 03/07→12/12 | FFBA | A2C59511609 | 12 |
| 1.8 TDCi | 92 kW  | 06/07→12/12 | QYBA | A2C59511609 | 12 |
|          |        |             | KHBA | A2C59511609 | 12 |
| 2.0 TDCi | 100 kW | 03/07→09/14 | UKBA | A2C59511600 | 11 |
|          |        |             | AZBC | A2C59511600 | 11 |



VDO

**FORD - MONDEO IV Turnier (BA7) 03/07→09/14****Diesel common rail pump**

|          |        |             |      |             |    |
|----------|--------|-------------|------|-------------|----|
| 2.0 TDCi | 103 kW | 03/07→09/14 | UFBA | A2C59511600 | 11 |
|          |        |             | QXBA | A2C59511600 | 11 |
|          |        |             | QXBB | A2C59511600 | 11 |

**FORD - RANGER (TKE) 04/11→****Diesel common rail piezo injector**

|              |        |        |         |             |    |
|--------------|--------|--------|---------|-------------|----|
| 2.2 TDCi     | 88 kW  | 04/11→ | GBVAJPF | A2C59517051 | 18 |
| 2.2 TDCi     | 92 kW  | 04/11→ | GBVAJQW | A2C59517051 | 18 |
| 2.2 TDCi     | 110 kW | 11/11→ | GBVAJQJ | A2C59517051 | 18 |
| 2.2 TDCi 4x4 | 92 kW  | 04/11→ | GBVAJQW | A2C59517051 | 18 |
| 2.2 TDCi 4x4 | 110 kW | 04/11→ | GBVAJQJ | A2C59517051 | 18 |
| 3.2 TDCi 4x4 | 147 kW | 04/11→ | SAFA    | A2C59517051 | 18 |

**Diesel common rail pump**

|              |        |        |                          |             |    |
|--------------|--------|--------|--------------------------|-------------|----|
| 2.2 TDCi     | 88 kW  | 04/11→ | GBVAJPF;  09/11          | A2C59517043 | 17 |
|              |        |        | GBVAJPF;  09/11 -  10/11 | A2C59517043 | 17 |
| 2.2 TDCi     | 92 kW  | 04/11→ | GBVAJQW;  09/11 -  10/11 | A2C59517043 | 17 |
|              |        |        | GBVAJQW;  09/11          | A2C59517043 | 17 |
| 2.2 TDCi     | 110 kW | 11/11→ | GBVAJQJ;  09/11          | A2C59517043 | 17 |
| 2.2 TDCi 4x4 | 92 kW  | 04/11→ | GBVAJQW;  09/11 -  10/11 | A2C59517043 | 17 |
|              |        |        | GBVAJQW;  09/11          | A2C59517043 | 17 |
| 2.2 TDCi 4x4 | 110 kW | 04/11→ | GBVAJQJ;  09/11          | A2C59517043 | 17 |
|              |        |        | GBVAJQJ;  09/11 -  10/11 | A2C59517043 | 17 |
| 3.2 TDCi 4x4 | 147 kW | 04/11→ | SAFA;  09/11 -  10/11    | A2C59517043 | 17 |
|              |        |        | SAFA;  09/11             | A2C59517043 | 17 |

**FORD - S-MAX (WA6) 05/06→****Diesel common rail piezo injector**

|          |        |        |  |             |    |
|----------|--------|--------|--|-------------|----|
| 1.6 TDCi | 85 kW  | 02/11→ |  | A2C59513556 | 15 |
| 1.8 TDCi | 74 kW  | 01/07→ | FFWA                                       | A2C59511610 | 12 |
| 1.8 TDCi | 92 kW  | 05/06→ | QYWA                                       | A2C59511610 | 12 |
| 2.0 TDCi | 100 kW | 05/06→ | UKWA / AZWC; Version (C2): 4               | 5WS40156-4Z | 8  |
|          |        |        | UKWA / AZWC; Version (C2): 5               | 5WS40156-Z  | 8  |
|          |        |        | AZWC / UKWA                                | A2C59511601 | 11 |
| 2.0 TDCi | 103 kW | 05/06→ | QXWA / QXWB / QXWC / UFWA; Version (C2): 4 | 5WS40156-4Z | 8  |
|          |        |        | QXWA / QXWB / QXWC / UFWA; Version (C2): 5 | 5WS40156-Z  | 8  |
|          |        |        | QXWC / QXWA / QXWB / UFWA                  | A2C59511601 | 11 |

**Diesel common rail pump**

|          |        |        |      |             |    |
|----------|--------|--------|------|-------------|----|
| 1.6 TDCi | 85 kW  | 02/11→ |      | A2C59513829 | 16 |
| 1.8 TDCi | 74 kW  | 01/07→ | FFWA | A2C59511609 | 12 |
| 1.8 TDCi | 92 kW  | 05/06→ | QYWA | A2C59511609 | 12 |
| 2.0 TDCi | 100 kW | 05/06→ | UKWA | A2C59511600 | 11 |
|          |        |        | AZWC | A2C59511600 | 11 |
| 2.0 TDCi | 103 kW | 05/06→ | QXWA | A2C59511600 | 11 |
|          |        |        | UFWA | A2C59511600 | 11 |
|          |        |        | QXWC | A2C59511600 | 11 |
|          |        |        | QXWB | A2C59511600 | 11 |

**FORD - TOURNEO CONNECT 06/02→12/13****Diesel common rail piezo injector**

|          |       |             |   |             |    |
|----------|-------|-------------|---|-------------|----|
| 1.8 TDCi | 66 kW | 06/02→12/13 | 08/06 ;<br>RWPF / HCPA / HCPB / R3PA / P9PD / P9PA / P9PC / P9PB / RWPE | A2C59511610 | 12 |
|          |       |             | 08/06 ;<br>RWPF, HCPA, HCPB / R3PA, P9PD, P9PA / P9PC, P9PB, RWPE       | A2C59511611 | 13 |



VDO

**FORD - TOURNEO CONNECT 06/02→12/13**
**Diesel common rail piezo injector**

|                    |       |             |                                    |                    |    |
|--------------------|-------|-------------|------------------------------------|--------------------|----|
| 1.8 TDCi           | 81 kW | 08/06→12/13 | RWPC                               | <b>A2C59511610</b> | 12 |
|                    |       |             | RWPD                               | <b>A2C59511610</b> | 12 |
|                    |       |             | RWPA                               | <b>A2C59511610</b> | 12 |
| 1.8 TDCi /TDDi /DI | 55 kW | 06/02→12/13 | 08/06 ;  P7PA / P7PB / R2PA / BHPA | <b>A2C59511610</b> | 12 |
|                    |       |             | 08/06 ;  P7PA, P7PB / R2PA, BHPA   | <b>A2C59511611</b> | 13 |

**Diesel common rail pump**

|                    |       |             |   |                    |    |
|--------------------|-------|-------------|---|--------------------|----|
| 1.8 TDCi           | 66 kW | 06/02→12/13 | 08/06 ;<br>RWPF / HCPA / HCPB / R3PA / P9PD / P9PA / P9PC / P9PB / RWPE | <b>A2C59511609</b> | 12 |
| 1.8 TDCi           | 81 kW | 08/06→12/13 | RWPA  | <b>A2C59511609</b> | 12 |
|                    |       |             | RWPC  | <b>A2C59511609</b> | 12 |
|                    |       |             | RWPD  | <b>A2C59511609</b> | 12 |
| 1.8 TDCi /TDDi /DI | 55 kW | 06/02→12/13 | 08/06 ;  P7PA / P7PB / R2PA / BHPA                                      | <b>A2C59511609</b> | 12 |

**FORD - TOURNEO CUSTOM Bus 04/12→**
**Diesel common rail piezo injector**

|          |        |        |  |                    |    |
|----------|--------|--------|--|--------------------|----|
| 2.2 TDCi | 74 kW  | 04/12→ |  | <b>A2C59517051</b> | 18 |
| 2.2 TDCi | 92 kW  | 04/12→ |  |                    |    |
| 2.2 TDCi | 114 kW | 04/12→ |  |                    |    |

**Diesel common rail pump**

|          |        |        |       |                    |    |
|----------|--------|--------|-------|--------------------|----|
| 2.2 TDCi | 74 kW  | 04/12→ | 09/11 | <b>A2C59517045</b> | 17 |
| 2.2 TDCi | 92 kW  | 04/12→ |       |                    |    |
| 2.2 TDCi | 114 kW | 04/12→ |       |                    |    |

**FORD - TRANSIT Box 10/07→08/14**
**Diesel common rail piezo injector**

|                |        |             |      |                    |    |
|----------------|--------|-------------|------|--------------------|----|
| 2.2 TDCi       | 74 kW  | 10/11→08/14 | DRFC | <b>A2C59517051</b> | 18 |
|                |        |             | DRFD | <b>A2C59517051</b> | 18 |
|                |        |             | DRFB | <b>A2C59517051</b> | 18 |
|                |        |             | DRFE | <b>A2C59517051</b> | 18 |
|                |        |             | DRFA | <b>A2C59517051</b> | 18 |
| 2.2 TDCi       | 92 kW  | 10/11→08/14 | CYFC | <b>A2C59517051</b> | 18 |
|                |        |             | CYFD | <b>A2C59517051</b> | 18 |
|                |        |             | CYFA | <b>A2C59517051</b> | 18 |
|                |        |             | CYFB | <b>A2C59517051</b> | 18 |
| 2.2 TDCi       | 103 kW | 10/07→08/14 | PGFB | <b>A2C59517051</b> | 18 |
|                |        |             | UHFA | <b>A2C59517051</b> | 18 |
| 2.2 TDCi [RWD] | 74 kW  | 10/11→08/14 |      |                    |    |
| 2.2 TDCi [RWD] | 92 kW  | 10/11→08/14 |      |                    |    |
| 2.2 TDCi [RWD] | 114 kW | 10/11→08/14 |      |                    |    |
| 2.2 TDCi 4x4   | 92 kW  | 10/11→08/14 | CYRC | <b>A2C59517051</b> | 18 |
|                |        |             | CYRB | <b>A2C59517051</b> | 18 |

**Diesel common rail pump**

|          |        |             |                       |                    |    |
|----------|--------|-------------|-----------------------|--------------------|----|
| 2.2 TDCi | 74 kW  | 10/11→08/14 | DRFD;  09/11 -  10/11 | <b>A2C59517043</b> | 17 |
|          |        |             | DRFE;  09/11 -  10/11 | <b>A2C59517043</b> | 17 |
|          |        |             | DRFC;  09/11 -  10/11 | <b>A2C59517043</b> | 17 |
|          |        |             | DRFA;  09/11 -  10/11 | <b>A2C59517043</b> | 17 |
|          |        |             | DRFB;  09/11 -  10/11 | <b>A2C59517043</b> | 17 |
| 2.2 TDCi | 92 kW  | 10/11→08/14 | CYFC;  09/11 -  10/11 | <b>A2C59517043</b> | 17 |
|          |        |             | CYFA;  09/11 -  10/11 | <b>A2C59517043</b> | 17 |
|          |        |             | CYFB;  09/11 -  10/11 | <b>A2C59517043</b> | 17 |
|          |        |             | CYFD;  09/11 -  10/11 | <b>A2C59517043</b> | 17 |
|          |        |             | CYFA;  09/11          | <b>A2C59517045</b> | 17 |
| 2.2 TDCi | 103 kW | 10/07→08/14 | UHFB;  09/11 -  10/11 | <b>A2C59517043</b> | 17 |
|          |        |             | PGFB;  09/11          | <b>A2C59517043</b> | 17 |
|          |        |             | UHFC;  09/11 -  10/11 | <b>A2C59517043</b> | 17 |
|          |        |             | PGFA;  09/11          | <b>A2C59517043</b> | 17 |

→



VDO

**FORD - TRANSIT Box 10/07→08/14****Diesel common rail pump**

|                |        |             |                       |             |             |
|----------------|--------|-------------|-----------------------|-------------|-------------|
| 2.2 TDCi       | 103 kW | 10/07→08/14 | PGFA;  10/11          | A2C59517043 | 17          |
|                |        |             | PGFB;  10/11          | A2C59517043 | 17          |
|                |        |             | UHFA;  09/11 -  10/11 | A2C59517043 | 17          |
|                |        |             | UHFA;  09/11          | A2C59517043 | 17          |
|                |        |             | PGFA;  09/11 -  10/11 | A2C59517043 | 17          |
|                |        |             | UHFC;  10/11          | A2C59517043 | 17          |
|                |        |             | UHFA;  10/11          | A2C59517043 | 17          |
|                |        |             | UHFB;  10/11          | A2C59517043 | 17          |
|                |        |             | UHFC;  09/11          | A2C59517043 | 17          |
|                |        |             | UHFB;  09/11          | A2C59517043 | 17          |
|                |        |             | PGFB;  09/11 -  10/11 | A2C59517043 | 17          |
|                |        |             | PGFB;  09/11 -  10/11 | A2C59517043 | 17          |
|                |        |             | 2.2 TDCi [RWD]        | 74 kW       | 10/11→08/14 |
| 2.2 TDCi [RWD] | 92 kW  | 10/11→08/14 | 09/11                 | A2C59517045 | 17          |
| 2.2 TDCi [RWD] | 114 kW | 10/11→08/14 |                       |             |             |
| 2.2 TDCi 4x4   | 92 kW  | 10/11→08/14 | CYRC;  09/11 -  10/11 | A2C59517043 | 17          |
|                |        |             | CYRB;  09/11 -  10/11 | A2C59517043 | 17          |
|                |        |             | CYRC;  09/11          | A2C59517045 | 17          |

**FORD - TRANSIT Bus 10/07→08/14****Diesel common rail piezo injector**

|                |        |             |      |             |    |
|----------------|--------|-------------|------|-------------|----|
| 2.2 TDCi       | 74 kW  | 10/11→08/14 | DRFC | A2C59517051 | 18 |
|                |        |             | DRFB | A2C59517051 | 18 |
| 2.2 TDCi       | 92 kW  | 10/11→08/14 | CYFC | A2C59517051 | 18 |
|                |        |             | CYFD | A2C59517051 | 18 |
|                |        |             | CYFA | A2C59517051 | 18 |
|                |        |             | CYFB | A2C59517051 | 18 |
|                |        |             | PGFA | A2C59517051 | 18 |
| 2.2 TDCi       | 103 kW | 10/07→08/14 | PGFA | A2C59517051 | 18 |
| 2.2 TDCi [RWD] | 74 kW  | 10/11→08/14 |      | A2C59517051 | 18 |
| 2.2 TDCi [RWD] | 92 kW  | 10/11→08/14 |      |             |    |
| 2.2 TDCi [RWD] | 100 kW | 09/11→08/14 |      |             |    |

**Diesel common rail pump**

|          |        |             |                       |             |             |       |             |    |
|----------|--------|-------------|-----------------------|-------------|-------------|-------|-------------|----|
| 2.2 TDCi | 74 kW  | 10/11→08/14 | DRFC;  09/11 -  10/11 | A2C59517043 | 17          |       |             |    |
|          |        |             | DRFD;  09/11 -  10/11 | A2C59517043 | 17          |       |             |    |
|          |        |             | DRFE;  09/11 -  10/11 | A2C59517043 | 17          |       |             |    |
|          |        |             | DRFA;  09/11 -  10/11 | A2C59517043 | 17          |       |             |    |
|          |        |             | DRFB;  09/11 -  10/11 | A2C59517043 | 17          |       |             |    |
|          |        |             | DRFB;  09/11          | A2C59517045 | 17          |       |             |    |
|          |        |             | DRFB;  09/11          | A2C59517045 | 17          |       |             |    |
| 2.2 TDCi | 92 kW  | 10/11→08/14 | CYFC;  09/11 -  10/11 | A2C59517043 | 17          |       |             |    |
|          |        |             | CYFA;  09/11 -  10/11 | A2C59517043 | 17          |       |             |    |
|          |        |             | CYFB;  09/11 -  10/11 | A2C59517043 | 17          |       |             |    |
|          |        |             | CYFD;  09/11 -  10/11 | A2C59517043 | 17          |       |             |    |
|          |        |             | CYFA;  09/11          | A2C59517045 | 17          |       |             |    |
|          |        |             | CYFA;  09/11          | A2C59517045 | 17          |       |             |    |
| 2.2 TDCi | 103 kW | 10/07→08/14 | UHFB;  09/11 -  10/11 | A2C59517043 | 17          |       |             |    |
|          |        |             | PGFB;  09/11          | A2C59517043 | 17          |       |             |    |
|          |        |             | UHFC;  09/11 -  10/11 | A2C59517043 | 17          |       |             |    |
|          |        |             | UHFA;  09/11 -  10/11 | A2C59517043 | 17          |       |             |    |
|          |        |             | PGFA;  10/11          | A2C59517043 | 17          |       |             |    |
|          |        |             | PGFB;  10/11          | A2C59517043 | 17          |       |             |    |
|          |        |             | PGFA;  09/11          | A2C59517043 | 17          |       |             |    |
|          |        |             | UHFA;  09/11          | A2C59517043 | 17          |       |             |    |
|          |        |             | PGFA;  09/11 -  10/11 | A2C59517043 | 17          |       |             |    |
|          |        |             | UHFC;  10/11          | A2C59517043 | 17          |       |             |    |
|          |        |             | UHFA;  10/11          | A2C59517043 | 17          |       |             |    |
|          |        |             | UHFB;  10/11          | A2C59517043 | 17          |       |             |    |
|          |        |             | UHFC;  09/11          | A2C59517043 | 17          |       |             |    |
|          |        |             | UHFB;  09/11          | A2C59517043 | 17          |       |             |    |
|          |        |             | PGFB;  09/11 -  10/11 | A2C59517043 | 17          |       |             |    |
|          |        |             | PGFB;  09/11          | A2C59517045 | 17          |       |             |    |
|          |        |             | 2.2 TDCi [RWD]        | 74 kW       | 10/11→08/14 | 09/11 | A2C59517045 | 17 |
|          |        |             | 2.2 TDCi [RWD]        | 92 kW       | 10/11→08/14 |       |             |    |





VDO



### FORD - TRANSIT Bus 10/07→08/14



#### Diesel common rail pump

|                |        |             |          |             |    |
|----------------|--------|-------------|----------|-------------|----|
| 2.2 TDCi [RWD] | 100 kW | 09/11→08/14 | ≡- 10/11 | A2C59517043 | 17 |
|                |        |             | ≡- 09/11 | A2C59517045 | 17 |

### FORD - TRANSIT CONNECT (P65\_, P70\_, P80\_) 06/02→12/13



#### Diesel common rail piezo injector

|          |       |             |   |             |    |
|----------|-------|-------------|---|-------------|----|
| 1.8 Di   | 55 kW | 06/02→12/13 | ≡- 12/07  | A2C59511610 | 12 |
|          |       |             | ≡- 12/07 ; ⚙ P7PA, P7PB / BHPA, R2PA  | A2C59511611 | 13 |
| 1.8 TDCi | 66 kW | 06/02→12/13 | ≡- 08/06 ;<br>⚙ P9PD / R3PA / P9PB / P9PC / RWPE / HCPA / HCPB /<br>P9PA / RWPF | A2C59511610 | 12 |
|          |       |             | ≡- 08/06 ;<br>⚙ P9PD, R3PA, P9PB / P9PC, RWPE, HCPA / HCPB, P9PA,<br>RWPF       | A2C59511611 | 13 |
| 1.8 TDCi | 81 kW | 08/06→12/13 | ⚙ RWPC  | A2C59511610 | 12 |
|          |       |             | ⚙ RWPD  | A2C59511610 | 12 |
|          |       |             | ⚙ RWPA  | A2C59511610 | 12 |



#### Diesel common rail pump

|          |       |             |   |             |    |
|----------|-------|-------------|---|-------------|----|
| 1.8 Di   | 55 kW | 06/02→12/13 | ≡- 12/07 ; ⚙ P7PA / BHPA / P7PB / R2PA  | A2C59511609 | 12 |
| 1.8 TDCi | 66 kW | 06/02→12/13 | ≡- 08/06 ;<br>⚙ P9PD / R3PA / P9PB / P9PC / RWPE / HCPA / HCPB /<br>P9PA / RWPF | A2C59511609 | 12 |
| 1.8 TDCi | 81 kW | 08/06→12/13 | ⚙ RWPA  | A2C59511609 | 12 |
|          |       |             | ⚙ RWPC  | A2C59511609 | 12 |
|          |       |             | ⚙ RWPD  | A2C59511609 | 12 |

### FORD - TRANSIT CUSTOM Box 04/12→



#### Diesel common rail piezo injector

|          |        |        |  |             |    |
|----------|--------|--------|--|-------------|----|
| 2.2 TDCi | 74 kW  | 04/12→ |  | A2C59517051 | 18 |
| 2.2 TDCi | 92 kW  | 04/12→ |  |             |    |
| 2.2 TDCi | 114 kW | 04/12→ |  |             |    |



#### Diesel common rail pump

|          |        |        |          |             |    |
|----------|--------|--------|----------|-------------|----|
| 2.2 TDCi | 74 kW  | 04/12→ | ≡- 09/11 | A2C59517045 | 17 |
| 2.2 TDCi | 92 kW  | 04/12→ |          |             |    |
| 2.2 TDCi | 114 kW | 04/12→ |          |             |    |

### FORD - TRANSIT CUSTOM Bus 04/12→



#### Diesel common rail piezo injector

|          |        |        |  |             |    |
|----------|--------|--------|--|-------------|----|
| 2.2 TDCi | 74 kW  | 04/12→ |  | A2C59517051 | 18 |
| 2.2 TDCi | 92 kW  | 04/12→ |  |             |    |
| 2.2 TDCi | 114 kW | 04/12→ |  |             |    |



#### Diesel common rail pump

|          |        |        |          |             |    |
|----------|--------|--------|----------|-------------|----|
| 2.2 TDCi | 74 kW  | 04/12→ | ≡- 09/11 | A2C59517045 | 17 |
| 2.2 TDCi | 92 kW  | 04/12→ |          |             |    |
| 2.2 TDCi | 114 kW | 04/12→ |          |             |    |

### FORD - TRANSIT Platform/Chassis 10/07→08/14



#### Diesel common rail piezo injector

|          |        |             |        |             |    |
|----------|--------|-------------|--------|-------------|----|
| 2.2 TDCi | 74 kW  | 10/11→08/14 | ⚙ DRFC | A2C59517051 | 18 |
|          |        |             | ⚙ DRFD | A2C59517051 | 18 |
|          |        |             | ⚙ DRFB | A2C59517051 | 18 |
|          |        |             | ⚙ DRFE | A2C59517051 | 18 |
|          |        |             | ⚙ DRFA | A2C59517051 | 18 |
| 2.2 TDCi | 92 kW  | 10/11→08/14 | ⚙ CYFC | A2C59517051 | 18 |
|          |        |             | ⚙ CYFD | A2C59517051 | 18 |
|          |        |             | ⚙ CYFA | A2C59517051 | 18 |
|          |        |             | ⚙ CYFB | A2C59517051 | 18 |
| 2.2 TDCi | 103 kW | 10/07→09/11 | ⚙ PGFB | A2C59517051 | 18 |
|          |        |             | ⚙ UHFC | A2C59517051 | 18 |



VDO

**FORD - TRANSIT Platform/Chassis 10/07→08/14**

| Diesel common rail piezo injector |                |             |  |                       |                |             |  |                       |                |
|-----------------------------------|----------------|-------------|--|-----------------------|----------------|-------------|--|-----------------------|----------------|
| 2.2 TDCi [RWD]                    | 74 kW          | 10/11→08/14 |  |                       | A2C59517051 18 |             |  |                       |                |
| 2.2 TDCi [RWD]                    | 92 kW          | 10/11→08/14 |  |                       |                |             |  |                       |                |
| 2.2 TDCi [RWD]                    | 114 kW         | 10/11→08/14 |  |                       |                |             |  |                       |                |
| 2.2 TDCi 4x4                      | 92 kW          | 10/11→08/14 |  | CYRB                  | A2C59517051 18 |             |  |                       |                |
| Diesel common rail pump           |                |             |  |                       |                |             |  |                       |                |
| 2.2 TDCi                          | 74 kW          | 10/11→08/14 |  | DRFD;  09/11 -  10/11 | A2C59517043 17 |             |  |                       |                |
|                                   |                |             |  | DRFE;  09/11 -  10/11 | A2C59517043 17 |             |  |                       |                |
|                                   |                |             |  | DRFC;  09/11 -  10/11 | A2C59517043 17 |             |  |                       |                |
|                                   |                |             |  | DRFA;  09/11 -  10/11 | A2C59517043 17 |             |  |                       |                |
|                                   |                |             |  | DRFB;  09/11 -  10/11 | A2C59517043 17 |             |  |                       |                |
| 2.2 TDCi                          | 92 kW          | 10/11→08/14 |  | DRFE;  09/11          | A2C59517045 17 |             |  |                       |                |
|                                   |                |             |  | CYFB;  09/11 -  10/11 | A2C59517043 17 |             |  |                       |                |
|                                   |                |             |  | CYFC;  09/11 -  10/11 | A2C59517043 17 |             |  |                       |                |
|                                   |                |             |  | CYFA;  09/11 -  10/11 | A2C59517043 17 |             |  |                       |                |
|                                   |                |             |  | CYFD;  09/11 -  10/11 | A2C59517043 17 |             |  |                       |                |
|                                   |                |             |  | CYFD;  09/11          | A2C59517045 17 |             |  |                       |                |
|                                   |                |             |  | CYFB;  09/11          | A2C59517045 17 |             |  |                       |                |
|                                   |                |             |  | CYFA;  09/11          | A2C59517045 17 |             |  |                       |                |
|                                   |                |             |  | 2.2 TDCi              | 103 kW         | 10/07→09/11 |  | UHFB;  09/11 -  10/11 | A2C59517043 17 |
|                                   |                |             |  |                       |                |             |  | UHFA;  09/11 -  10/11 | A2C59517043 17 |
| UHFC;  09/11 -  10/11             | A2C59517043 17 |             |  |                       |                |             |  |                       |                |
| PGFA;  09/11 -  10/11             | A2C59517043 17 |             |  |                       |                |             |  |                       |                |
| PGFB;  09/11 -  10/11             | A2C59517043 17 |             |  |                       |                |             |  |                       |                |
| 2.2 TDCi [RWD]                    | 74 kW          | 10/11→08/14 |  | 09/11                 | A2C59517045 17 |             |  |                       |                |
|                                   | 92 kW          | 10/11→08/14 |  |                       |                |             |  |                       |                |
|                                   | 114 kW         | 10/11→08/14 |  |                       |                |             |  |                       |                |
| 2.2 TDCi 4x4                      | 92 kW          | 10/11→08/14 |  | CYRC;  09/11 -  10/11 | A2C59517043 17 |             |  |                       |                |
|                                   |                |             |  | CYRB;  09/11 -  10/11 | A2C59517043 17 |             |  |                       |                |
|                                   |                |             |  | CYRB;  09/11          | A2C59517045 17 |             |  |                       |                |
|                                   |                |             |  | CYRC;  09/11          | A2C59517045 17 |             |  |                       |                |

**FORD - TRANSIT TOURNEO 10/07→08/14**

| Diesel common rail piezo injector |        |             |  |                       |                |
|-----------------------------------|--------|-------------|--|-----------------------|----------------|
| 2.2 TDCi                          | 103 kW | 10/07→08/14 |  | PGFA                  | A2C59517051 18 |
| Diesel common rail pump           |        |             |  |                       |                |
| 2.2 TDCi                          | 103 kW | 10/07→08/14 |  | PGFB;  10/11          | A2C59517043 17 |
|                                   |        |             |  | PGFA;  10/11          | A2C59517043 17 |
|                                   |        |             |  | PGFA;  09/11 -  10/11 | A2C59517043 17 |
|                                   |        |             |  | PGFB;  09/11          | A2C59517043 17 |
|                                   |        |             |  | PGFA;  09/11          | A2C59517043 17 |

**JAGUAR - S-TYPE Saloon (CCX) 06/04→10/07**

| Diesel common rail piezo injector |        |             |  |     |                |
|-----------------------------------|--------|-------------|--|-----|----------------|
| 2.7 D                             | 152 kW | 06/04→10/07 |  | AJD | A2C59511316 10 |
| Diesel common rail pump           |        |             |  |     |                |
| 2.7 D                             | 152 kW | 06/04→10/07 |  | AJD | A2C59511314 10 |

**JAGUAR - XF Saloon (\_J05\_, CC9) 03/08→04/15**

| Diesel common rail piezo injector |        |             |  |     |                |
|-----------------------------------|--------|-------------|--|-----|----------------|
| 2.7 D                             | 152 kW | 03/08→04/15 |  | AJD | A2C59511316 10 |
| Diesel common rail pump           |        |             |  |     |                |
| 2.7 D                             | 152 kW | 03/08→04/15 |  | AJD | A2C59511314 10 |



|   |  |             |  |        |              | VDO                |                    |    |
|---|--|-------------|--|--------|--------------|--------------------|--------------------|----|
| <b>LAND ROVER - DEFENDER Cabrio (LD) 08/11→</b>           |  |             |  |        |              |                    |                    |    |
|   | <b>Diesel common rail pump</b>           |             |  |        |              |                    |                    |    |
| 2.2 Td4 4x4   | 90 kW                                    | 08/11→      |  |        |              | <b>A2C59517043</b> | 17                 |    |
| <b>LAND ROVER - DEFENDER Pickup (LD_) 08/11→</b>          |  |             |  |        |              |                    |                    |    |
|   | <b>Diesel common rail pump</b>           |             |  |        |              |                    |                    |    |
| 2.2 Td4 4x4   | 90 kW                                    | 08/11→      |  |        |              | <b>A2C59517043</b> | 17                 |    |
| <b>LAND ROVER - DEFENDER Platform/Chassis (LD) 08/11→</b> |  |             |  |        |              |                    |                    |    |
|   | <b>Diesel common rail pump</b>           |             |  |        |              |                    |                    |    |
| 2.2 Td4 4x4   | 90 kW                                    | 08/11→      |  |        |              | <b>A2C59517043</b> | 17                 |    |
| <b>LAND ROVER - DEFENDER Station Wagon (LD) 08/11→</b>    |  |             |  |        |              |                    |                    |    |
|   | <b>Diesel common rail pump</b>           |             |  |        |              |                    |                    |    |
| 2.2 Td4 4x4   | 90 kW                                    | 08/11→      |  |        |              | <b>A2C59517043</b> | 17                 |    |
| <b>LAND ROVER - DISCOVERY III (TAA, LA_) 07/04→09/09</b>  |  |             |  |        |              |                    |                    |    |
|   | <b>Diesel common rail piezo injector</b> |             |  |        |              |                    |                    |    |
| 2.7 TD 4x4  | 140 kW                                   | 07/04→09/09 |  | 276DT  |              | <b>A2C59511364</b> | 10                 |    |
|   |  |             |  | 276DT; | → 7A000001   | <b>A2C59513553</b> | 14                 |    |
|   | <b>Diesel common rail pump</b>           |             |  |        |              |                    |                    |    |
| 2.7 TD 4x4  | 140 kW                                   | 07/04→09/09 |  | 276DT  |              | <b>A2C59511314</b> | 10                 |    |
|   |  |             |  | 276DT; | → 9A000001   | <b>A2C59511314</b> | 10                 |    |
|   |  |             |  | 276DT; | → 8A999999   | <b>A2C59511314</b> | 10                 |    |
|   |  |             |  | 276DT; | → 7A000001 → | 8A463765           | <b>A2C59513482</b> | 13 |
|   |  |             |  | 276DT; | → 7A000001 → | 9A509802           | <b>A2C59513482</b> | 13 |
|   |  |             |  | 276DT; | → 8A463766 → | 9A509802           | <b>A2C59513482</b> | 13 |
|   |  |             |  | 276DT; | → 9A509803   | <b>A2C59513482</b> | 13                 |    |
| <b>LAND ROVER - DISCOVERY IV (LA) 09/09→</b>              |  |             |  |        |              |                    |                    |    |
|   | <b>Diesel common rail piezo injector</b> |             |  |        |              |                    |                    |    |
| 2.7 TD 4x4  | 140 kW                                   | 09/09→      |  | 276DT; | → AA000001   | <b>A2C59513553</b> | 14                 |    |
|   |  |             |  | 276DT  |              | <b>A2C59513553</b> | 14                 |    |
|   | <b>Diesel common rail pump</b>           |             |  |        |              |                    |                    |    |
| 2.7 TD 4x4  | 140 kW                                   | 09/09→      |  | 276DT; | → AA000001   | <b>A2C59513482</b> | 13                 |    |
|   |  |             |  | 276DT  |              | <b>A2C59513482</b> | 13                 |    |
| <b>LAND ROVER - RANGE ROVER III (LM) 04/06→08/12</b>      |  |             |  |        |              |                    |                    |    |
|   | <b>Diesel common rail piezo injector</b> |             |  |        |              |                    |                    |    |
| 3.6 D 4x4   | 200 kW                                   | 04/06→08/12 |  | 368DT; | → 7A000001   | <b>A2C59513597</b> | 16                 |    |
|   | <b>Diesel common rail pump</b>           |             |  |        |              |                    |                    |    |
| 3.6 D 4x4   | 200 kW                                   | 04/06→08/12 |  | 368DT; | → 8A273646   | <b>A2C59513481</b> | 13                 |    |
|   |  |             |  | 368DT; | → 7A000001 → | 8A273645           | <b>A2C59513481</b> | 13 |
| <b>LAND ROVER - RANGE ROVER SPORT (LS) 02/05→03/13</b>    |  |             |  |        |              |                    |                    |    |
|   | <b>Diesel common rail piezo injector</b> |             |  |        |              |                    |                    |    |
| 2.7 D 4x4   | 140 kW                                   | 02/05→03/13 |  | 276DT  |              | <b>A2C59511364</b> | 10                 |    |
|   |  |             |  | 276DT; | → 7A000001   | <b>A2C59513553</b> | 14                 |    |
| 3.6 D 4x4   | 200 kW                                   | 04/06→03/13 |  | 368DT; | → 7A000001   | <b>A2C59513597</b> | 16                 |    |
|   | <b>Diesel common rail pump</b>           |             |  |        |              |                    |                    |    |
| 2.7 D 4x4   | 140 kW                                   | 02/05→03/13 |  | 276DT  |              | <b>A2C59511314</b> | 10                 |    |
|   |  |             |  | 276DT; | → 9A000001   | <b>A2C59511314</b> | 10                 |    |
|   |  |             |  | 276DT; | → 8A999999   | <b>A2C59511314</b> | 10                 |    |
|   |  |             |  | 276DT; | → 7A000001 → | 9A211714           | <b>A2C59513482</b> | 13 |
|   |  |             |  | 276DT; | → 9A211715   | <b>A2C59513482</b> | 13                 |    |

→



VDO

**LAND ROVER - RANGE ROVER SPORT (LS) 02/05→03/13****Diesel common rail pump**

|           |        |             |                                |                    |    |
|-----------|--------|-------------|--------------------------------|--------------------|----|
| 2.7 D 4x4 | 140 kW | 02/05→03/13 | 276DT;  → 7A000001 →  8A147001 | <b>A2C59513482</b> | 13 |
|           |        |             | 276DT;  → 8A147002 →  9A211714 | <b>A2C59513482</b> | 13 |
| 3.6 D 4x4 | 200 kW | 04/06→03/13 | 368DT;  → 8A273646             | <b>A2C59513481</b> | 13 |
|           |        |             | 368DT;  → 7A000001 →  8A273645 | <b>A2C59513481</b> | 13 |

**MERCEDES-BENZ - A-CLASS (W176) 06/12→****Diesel common rail piezo injector**

|                         |       |        |            |                    |   |
|-------------------------|-------|--------|------------|--------------------|---|
| A 160 CDI / d (176.011) | 66 kW | 06/13→ | OM 607.951 | <b>A2C59507596</b> | 9 |
| A 180 CDI / d (176.012) | 80 kW | 06/12→ |            |                    |   |

**Diesel common rail pump**

|                         |       |        |            |                    |   |
|-------------------------|-------|--------|------------|--------------------|---|
| A 160 CDI / d (176.011) | 66 kW | 06/13→ | OM 607.951 | <b>A2C59507608</b> | 9 |
| A 180 CDI / d (176.012) | 80 kW | 06/12→ |            |                    |   |

**MERCEDES-BENZ - B-CLASS (W246, W242) 02/13→****Diesel common rail piezo injector**

|                         |       |        |            |                    |   |
|-------------------------|-------|--------|------------|--------------------|---|
| B 160 CDI / d (246.211) | 66 kW | 05/13→ | OM 607.951 | <b>A2C59507596</b> | 9 |
| B 180 CDI / d (246.212) | 80 kW | 02/13→ |            |                    |   |

**Diesel common rail pump**

|                         |       |        |            |                    |   |
|-------------------------|-------|--------|------------|--------------------|---|
| B 160 CDI / d (246.211) | 66 kW | 05/13→ | OM 607.951 | <b>A2C59507608</b> | 9 |
| B 180 CDI / d (246.212) | 80 kW | 02/13→ |            |                    |   |

**MERCEDES-BENZ - CITAN Box (415) 11/12→****Diesel common rail piezo injector**

|                                     |       |        |            |                    |   |
|-------------------------------------|-------|--------|------------|--------------------|---|
| 108 CDI (415.601, 415.603)          | 55 kW | 11/12→ | OM 607.951 | <b>A2C59507596</b> | 9 |
| 109 CDI (415.601, 415.603, 415.605) | 66 kW | 11/12→ |            |                    |   |
| 111 CDI (415.603, 415.605)          | 81 kW | 06/13→ |            |                    |   |

**Diesel common rail pump**

|                                     |       |        |            |                    |   |
|-------------------------------------|-------|--------|------------|--------------------|---|
| 108 CDI (415.601, 415.603)          | 55 kW | 11/12→ | OM 607.951 | <b>A2C59507608</b> | 9 |
| 109 CDI (415.601, 415.603, 415.605) | 66 kW | 11/12→ |            |                    |   |
| 111 CDI (415.603, 415.605)          | 81 kW | 06/13→ |            |                    |   |

**MERCEDES-BENZ - CITAN Combi (415) 11/12→****Diesel common rail piezo injector**

|                   |       |        |            |                    |   |
|-------------------|-------|--------|------------|--------------------|---|
| 108 CDI (415.703) | 55 kW | 11/12→ | OM 607.951 | <b>A2C59507596</b> | 9 |
| 109 CDI (415.703) | 66 kW | 11/12→ |            |                    |   |
| 111 CDI (415.703) | 81 kW | 06/13→ |            |                    |   |

**Diesel common rail pump**

|                   |       |        |            |                    |   |
|-------------------|-------|--------|------------|--------------------|---|
| 108 CDI (415.703) | 55 kW | 11/12→ | OM 607.951 | <b>A2C59507608</b> | 9 |
| 109 CDI (415.703) | 66 kW | 11/12→ |            |                    |   |
| 111 CDI (415.703) | 81 kW | 06/13→ |            |                    |   |

**MERCEDES-BENZ - CITAN Mixto (415) 11/12→****Diesel common rail piezo injector**

|                                     |       |        |            |                    |   |
|-------------------------------------|-------|--------|------------|--------------------|---|
| 109 CDI                             | 66 kW | 11/12→ | OM 607.951 | <b>A2C59507596</b> | 9 |
| 111 CDI (415.601, 415.603, 415.605) | 81 kW | 06/13→ |            |                    |   |

**Diesel common rail pump**

|                                     |       |        |            |                    |   |
|-------------------------------------|-------|--------|------------|--------------------|---|
| 109 CDI                             | 66 kW | 11/12→ | OM 607.951 | <b>A2C59507608</b> | 9 |
| 111 CDI (415.601, 415.603, 415.605) | 81 kW | 06/13→ |            |                    |   |



| <b>MERCEDES-BENZ - CLA Coupe (C117) 10/13→</b>          |  |
|---|--|
| <b>Diesel common rail piezo injector</b>                |  |
| CLA 180 CDI / d<br>(117.312)                            | 80 kW 10/13→  OM 607.951 <b>A2C59507596</b> 9        |
| <b>Diesel common rail pump</b>                          |  |
| CLA 180 CDI / d<br>(117.312)                            | 80 kW 10/13→  OM 607.951 <b>A2C59507608</b> 9        |
| <b>MERCEDES-BENZ - CLA Shooting Brake (X117) 07/15→</b> |  |
| <b>Diesel common rail piezo injector</b>                |  |
| CLA 180 d (117.912)                                     | 80 kW 07/15→  OM 607.951 <b>A2C59507596</b> 9        |
| <b>Diesel common rail pump</b>                          |  |
| CLA 180 d (117.912)                                     | 80 kW 07/15→  OM 607.951 <b>A2C59507608</b> 9        |
| <b>MERCEDES-BENZ - GLA-CLASS (X156) 07/14→</b>          |  |
| <b>Diesel common rail piezo injector</b>                |  |
| GLA 180 CDI / d<br>(156.912)                            | 80 kW 07/14→  OM 607.951 <b>A2C59507596</b> 9        |
| <b>Diesel common rail pump</b>                          |  |
| GLA 180 CDI / d<br>(156.912)                            | 80 kW 07/14→  OM 607.951 <b>A2C59507608</b> 9        |
| <b>NISSAN - CUBE (Z12) 03/10→</b>                       |  |
| <b>Diesel common rail piezo injector</b>                |  |
| 1.5 dCi   | 81 kW 03/10→ <b>A2C59513484</b> 14                   |
| <b>Diesel common rail pump</b>                          |  |
| 1.5 dCi   | 81 kW 03/10→ <b>A2C59513595</b> 15                   |
| <b>NISSAN - DUALIS (J10, JJ10) 02/07→</b>               |  |
| <b>Diesel common rail piezo injector</b>                |  |
| 1.5 dCi   | 78 kW 02/07→ <b>A2C59511606</b> 12                   |
| 1.5 dCi   | 81 kW 11/10→ <b>A2C59513484</b> 14                   |
| <b>Diesel common rail pump</b>                          |  |
| 1.5 dCi   | 78 kW 02/07→ <b>A2C59511605</b> 12                   |
| 1.5 dCi   | 81 kW 11/10→   |
| <b>NISSAN - JUKE (F15) 06/10→</b>                       |  |
| <b>Diesel common rail piezo injector</b>                |  |
| 1.5 dCi   | 81 kW 06/10→  K9K 636 <b>A2C59507596</b> 9           |
|   | K9K 896 <b>A2C59513484</b> 14                        |
| <b>Diesel common rail pump</b>                          |  |
| 1.5 dCi   | 81 kW 06/10→  K9K 636 <b>A2C59507608</b> 9           |
|   | K9K 896 <b>A2C59513595</b> 15                        |
| <b>NISSAN - NOTE (E11) 07/08→</b>                       |  |
| <b>Diesel common rail piezo injector</b>                |  |
| 1.5 dCi   | 76 kW 07/08→ <b>A2C59511606</b> 12                   |
| <b>Diesel common rail pump</b>                          |  |
| 1.5 dCi   | 76 kW 07/08→ <b>A2C59511605</b> 12                   |
| <b>NISSAN - NV200 / EVALIA Bus 04/11→</b>               |  |
| <b>Diesel common rail piezo injector</b>                |  |
| 1.5 dci (M20, M20M)                                     | 81 kW 04/11→  K9K 636 / K9K 646 <b>A2C59507596</b> 9 |



|   |       |        |                           | VDO                |    |
|---|-------|--------|---------------------------|--------------------|----|
| <b>NISSAN - NV200 / EVALIA Bus 04/11→</b>     |       |        |                           |                    |    |
| <b>Diesel common rail pump</b>                |       |        |                           |                    |    |
| 1.5 dci (M20, M20M)                           | 81 kW | 04/11→ | K9K 636 / K9K 646         | <b>A2C59507608</b> | 9  |
| <b>NISSAN - NV200 Box 04/11→</b>              |       |        |                           |                    |    |
| <b>Diesel common rail piezo injector</b>      |       |        |                           |                    |    |
| 1.5 dci (M20, M20M)                           | 81 kW | 04/11→ | K9K 636 / K9K 646         | <b>A2C59507596</b> | 9  |
| <b>Diesel common rail pump</b>                |       |        |                           |                    |    |
| 1.5 dci (M20, M20M)                           | 81 kW | 04/11→ | K9K 636 / K9K 646         | <b>A2C59507608</b> | 9  |
| <b>NISSAN - QASHQAI (J11, J11_) 11/13→</b>    |       |        |                           |                    |    |
| <b>Diesel common rail piezo injector</b>      |       |        |                           |                    |    |
| 1.5 dCi                                       | 81 kW | 11/13→ | K9K 636                   | <b>A2C59507596</b> | 9  |
| <b>Diesel common rail pump</b>                |       |        |                           |                    |    |
| 1.5 dCi                                       | 81 kW | 11/13→ | K9K 636                   | <b>A2C59507608</b> | 9  |
| <b>NISSAN - TIIDA Hatchback (C11X) 09/07→</b> |       |        |                           |                    |    |
| <b>Diesel common rail piezo injector</b>      |       |        |                           |                    |    |
| 1.5 dCi                                       | 78 kW | 09/07→ |                           | <b>A2C59511606</b> | 12 |
| <b>Diesel common rail pump</b>                |       |        |                           |                    |    |
| 1.5 dCi                                       | 78 kW | 09/07→ |                           | <b>A2C59511605</b> | 12 |
| <b>NISSAN - TIIDA Saloon (SC11X) 09/07→</b>   |       |        |                           |                    |    |
| <b>Diesel common rail piezo injector</b>      |       |        |                           |                    |    |
| 1.5 dCi                                       | 78 kW | 09/07→ |                           | <b>A2C59511606</b> | 12 |
| <b>Diesel common rail pump</b>                |       |        |                           |                    |    |
| 1.5 dCi                                       | 78 kW | 09/07→ |                           | <b>A2C59511605</b> | 12 |
| <b>PEUGEOT - 107 06/05→</b>                   |       |        |                           |                    |    |
| <b>Diesel common rail piezo injector</b>      |       |        |                           |                    |    |
| 1.4 HDi                                       | 40 kW | 06/05→ | 8HT (DV4TD)               | <b>A2C59511612</b> | 13 |
| <b>Diesel common rail pump</b>                |       |        |                           |                    |    |
| 1.4 HDi                                       | 40 kW | 06/05→ | 8HT (DV4TD)               | <b>5WS40008-Z</b>  | 7  |
| <b>PEUGEOT - 207 CC (WD_) 08/09→</b>          |       |        |                           |                    |    |
| <b>Diesel common rail piezo injector</b>      |       |        |                           |                    |    |
| 1.6 HDi                                       | 82 kW | 08/09→ | 9HR (DV6C);  03/10        | <b>A2C59513556</b> | 15 |
|   |       |        | 9HR (DV6C);  12/11        | <b>A2C59513556</b> | 15 |
| <b>Diesel common rail pump</b>                |       |        |                           |                    |    |
| 1.6 HDi                                       | 82 kW | 08/09→ | 9HR (DV6C);  07/10        | <b>A2C59513830</b> | 16 |
|   |       |        | 9HR (DV6C);  06/10        | <b>A2C59513830</b> | 16 |
| <b>PEUGEOT - 207 SW Estate (WK_) 08/09→</b>   |       |        |                           |                    |    |
| <b>Diesel common rail piezo injector</b>      |       |        |                           |                    |    |
| 1.6 HDi                                       | 82 kW | 08/09→ | 9HR (DV6C);  03/10  12/11 | <b>A2C59513556</b> | 15 |
|   |       |        | 9HR (DV6C);  03/10        | <b>A2C59513556</b> | 15 |
|   |       |        | 9HR (DV6C);  12/11        | <b>A2C59513556</b> | 15 |
| <b>Diesel common rail pump</b>                |       |        |                           |                    |    |
| 1.6 HDi                                       | 82 kW | 08/09→ | 9HR (DV6C);  07/10        | <b>A2C59513830</b> | 16 |
|   |       |        | 9HR (DV6C);  06/10        | <b>A2C59513830</b> | 16 |



| <b>PEUGEOT - 208 03/12→</b>              |  |
|--|--|
| <b>Diesel common rail piezo injector</b> |  |
| 1.6 HDi                                  | 84 kW 03/12→ <b>A2C59513556</b> 15                                   |
| <b>Diesel common rail pump</b>           |  |
| 1.6 HDi                                  | 84 kW 03/12→  07/10 <b>A2C59513830</b> 16                            |
| <b>PEUGEOT - 307 (3A/C) 08/00→</b>       |  |
| <b>Diesel common rail piezo injector</b> |  |
| 2.0 HDi 135                              | 100 kW 10/03→  RHR (DW10BTED4); Version (C2): 4 <b>5WS40156-4Z</b> 8 |
|  | RHR (DW10BTED4); Version (C2): 5 <b>5WS40156-Z</b> 8                 |
|  | RHR (DW10BTED4); Version (C2): 6 <b>A2C59511601</b> 11               |
| 2.0 HDi 90                               | 66 kW 08/00→  RHY (DW10TD) <b>5WS40000-Z</b> 7                       |
| <b>Diesel common rail pump</b>           |  |
| 2.0 HDi 135                              | 100 kW 10/03→  RHR (DW10BTED4) <b>5WS40809-Z</b> 9                   |
| <b>PEUGEOT - 307 Break (3E) 03/02→</b>   |  |
| <b>Diesel common rail piezo injector</b> |  |
| 2.0 HDi 135                              | 100 kW 02/04→  RHR (DW10BTED4); Version (C2): 4 <b>5WS40156-4Z</b> 8 |
|  | RHR (DW10BTED4); Version (C2): 5 <b>5WS40156-Z</b> 8                 |
|  | RHR (DW10BTED4); Version (C2): 6 <b>A2C59511601</b> 11               |
|  | <b>A2C59513552</b> 14  |
| 2.0 HDi 90                               | 66 kW 03/02→  RHY (DW10TD) <b>5WS40000-Z</b> 7                       |
| <b>Diesel common rail pump</b>           |  |
| 2.0 HDi 135                              | 100 kW 02/04→  RHR (DW10BTED4) <b>5WS40809-Z</b> 9                   |
| <b>PEUGEOT - 307 CC (3B) 06/05→</b>      |  |
| <b>Diesel common rail piezo injector</b> |  |
| 2.0 HDi 135                              | 100 kW 06/05→  RHR (DW10BTED4); Version (C2): 4 <b>5WS40156-4Z</b> 8 |
|  | RHR (DW10BTED4); Version (C2): 5 <b>5WS40156-Z</b> 8                 |
|  | RHR (DW10BTED4); Version (C2): 6 <b>A2C59511601</b> 11               |
|  | <b>A2C59513552</b> 14  |
| <b>Diesel common rail pump</b>           |  |
| 2.0 HDi 135                              | 100 kW 06/05→  RHR (DW10BTED4) <b>5WS40809-Z</b> 9                   |
| <b>PEUGEOT - 307 SW (3H) 03/02→</b>      |  |
| <b>Diesel common rail piezo injector</b> |  |
| 2.0 HDi 135                              | 100 kW 02/04→  RHR (DW10BTED4); Version (C2): 4 <b>5WS40156-4Z</b> 8 |
|  | RHR (DW10BTED4); Version (C2): 5 <b>5WS40156-Z</b> 8                 |
|  | RHR (DW10BTED4); Version (C2): 6 <b>A2C59511601</b> 11               |
|  | <b>A2C59513552</b> 14  |
| 2.0 HDi 90                               | 66 kW 03/02→  RHY (DW10TD) <b>5WS40000-Z</b> 7                       |
| <b>Diesel common rail pump</b>           |  |
| 2.0 HDi 135                              | 100 kW 02/04→  RHR (DW10BTED4) <b>5WS40809-Z</b> 9                   |
| <b>PEUGEOT - 308 (4A_, 4C_) 09/07→</b>   |  |
| <b>Diesel common rail piezo injector</b> |  |
| 1.6 HDi                                  | 66 kW 09/07→  03/10 <b>A2C59513556</b> 15                            |
|  | 03/10  12/11 <b>A2C59513556</b> 15                                   |
|  | 12/11 <b>A2C59513556</b> 15  |
|  | 12/11 <b>A2C59513556</b> 15  |
| 1.6 HDi                                  | 82 kW 12/09→  9HR (DV6C);  12/11 <b>A2C59513556</b> 15               |
|  | 9HR (DV6C);  03/10  12/11 <b>A2C59513556</b> 15                      |
|  | 9HR (DV6C);  03/10 <b>A2C59513556</b> 15                             |
|  | 9HR (DV6C);  12/11 <b>A2C59513556</b> 15                             |
| 1.6 HDi                                  | 84 kW 03/13→ <b>A2C59513556</b> 15                                   |



|   |        |             |                                  | VDO         |    |
|---|--------|-------------|----------------------------------|-------------|----|
| <b>PEUGEOT - 308 (4A_, 4C_) 09/07→</b>        |        |             |                                  |             |    |
| <b>Diesel common rail pump</b>                |        |             |                                  |             |    |
| 1.6 HDi                                       | 66 kW  | 09/07→      | 07/10                            | A2C59513830 | 16 |
|   |        |             | 06/10                            | A2C59513830 | 16 |
| 1.6 HDi                                       | 82 kW  | 12/09→      | 9HR (DV6C);  06/10               | A2C59513830 | 16 |
|   |        |             | 9HR (DV6C);  07/10               | A2C59513830 | 16 |
| 1.6 HDi                                       | 84 kW  | 03/13→      | 07/10                            | A2C59513830 | 16 |
| <b>PEUGEOT - 308 II 09/13→</b>                |        |             |                                  |             |    |
| <b>Diesel common rail piezo injector</b>      |        |             |                                  |             |    |
| 1.6 HDi                                       | 68 kW  | 09/13→      |                                  | A2C59513556 | 15 |
| 1.6 HDi / BlueHDi 115                         | 85 kW  | 09/13→      |                                  |             |    |
| <b>Diesel common rail pump</b>                |        |             |                                  |             |    |
| 1.6 HDi                                       | 68 kW  | 09/13→      | 07/10                            | A2C59513830 | 16 |
| 1.6 HDi / BlueHDi 115                         | 85 kW  | 09/13→      |                                  |             |    |
| <b>PEUGEOT - 308 CC 06/09→</b>                |        |             |                                  |             |    |
| <b>Diesel common rail piezo injector</b>      |        |             |                                  |             |    |
| 1.6 HDi                                       | 82 kW  | 06/09→      | 9HR (DV6C);  03/10               | A2C59513556 | 15 |
|   |        |             | 9HR (DV6C);  03/10  12/11        | A2C59513556 | 15 |
|   |        |             | 9HR (DV6C);  12/11               | A2C59513556 | 15 |
|   |        |             | 9HR (DV6C);  12/11               | A2C59513556 | 15 |
| 1.6 HDi                                       | 84 kW  | 03/13→      |                                  | A2C59513556 | 15 |
| <b>Diesel common rail pump</b>                |        |             |                                  |             |    |
| 1.6 HDi                                       | 82 kW  | 06/09→      | 9HR (DV6C);  07/10               | A2C59513830 | 16 |
|   |        |             | 9HR (DV6C);  06/10               | A2C59513830 | 16 |
| 1.6 HDi                                       | 84 kW  | 03/13→      | 07/10                            | A2C59513830 | 16 |
| <b>PEUGEOT - 308 SW Estate 12/09→</b>         |        |             |                                  |             |    |
| <b>Diesel common rail piezo injector</b>      |        |             |                                  |             |    |
| 1.6 HDi                                       | 82 kW  | 12/09→      | 9HR (DV6C);  03/10               | A2C59513556 | 15 |
|   |        |             | 9HR (DV6C);  03/10  12/11        | A2C59513556 | 15 |
|   |        |             | 9HR (DV6C);  12/11               | A2C59513556 | 15 |
|   |        |             | 9HR (DV6C);  12/11               | A2C59513556 | 15 |
| 1.6 HDi                                       | 84 kW  | 03/13→      |                                  | A2C59513556 | 15 |
| <b>Diesel common rail pump</b>                |        |             |                                  |             |    |
| 1.6 HDi                                       | 82 kW  | 12/09→      | 9HR (DV6C);  07/10               | A2C59513830 | 16 |
| 1.6 HDi                                       | 84 kW  | 03/13→      | 07/10                            | A2C59513830 | 16 |
| <b>PEUGEOT - 406 Break (8E/F) 02/99→10/04</b> |        |             |                                  |             |    |
| <b>Diesel common rail piezo injector</b>      |        |             |                                  |             |    |
| 2.0 HDi 90                                    | 66 kW  | 02/99→10/04 | RHY (DW10TD)                     | 5WS40000-Z  | 7  |
| <b>PEUGEOT - 406 Saloon (8B) 02/99→05/04</b>  |        |             |                                  |             |    |
| <b>Diesel common rail piezo injector</b>      |        |             |                                  |             |    |
| 2.0 HDi 90                                    | 66 kW  | 02/99→05/04 | RHY (DW10TD)                     | 5WS40000-Z  | 7  |
| <b>PEUGEOT - 407 Coupe (6C_) 10/05→</b>       |        |             |                                  |             |    |
| <b>Diesel common rail piezo injector</b>      |        |             |                                  |             |    |
| 2.0 HDi                                       | 100 kW | 10/05→      | RHR (DW10BTED4); Version (C2): 4 | 5WS40156-4Z | 8  |
|   |        |             | RHR (DW10BTED4); Version (C2): 5 | 5WS40156-Z  | 8  |
|   |        |             | RHR (DW10BTED4); Version (C2): 6 | A2C59511601 | 11 |
| 2.7 HDi                                       | 150 kW | 10/05→      | UHZ (DT17)                       | A2C59511316 | 10 |
| <b>Diesel common rail pump</b>                |        |             |                                  |             |    |
| 2.0 HDi                                       | 100 kW | 10/05→      | RHR (DW10BTED4)                  | 5WS40809-Z  | 9  |
| 2.7 HDi                                       | 150 kW | 10/05→      | UHZ (DT17)                       | A2C59511314 | 10 |





VDO

**PEUGEOT - 407 Saloon (6D\_) 05/04→**
**Diesel common rail piezo injector**

|             |        |        |                                  |                    |    |
|-------------|--------|--------|----------------------------------|--------------------|----|
| 2.0 HDi     | 103 kW | 08/08→ | RHF (DW10BTED4); Version (C2): 4 | <b>5WS40156-4Z</b> | 8  |
|             |        |        | RHR (DW10BTED4)                  | <b>5WS40156-Z</b>  | 8  |
|             |        |        | RHF (DW10BTED4); Version (C2): 6 | <b>A2C59511601</b> | 11 |
| 2.0 HDi 135 | 100 kW | 05/04→ | RHR (DW10BTED4); Version (C2): 4 | <b>5WS40156-4Z</b> | 8  |
|             |        |        | RHR (DW10BTED4); Version (C2): 5 | <b>5WS40156-Z</b>  | 8  |
|             |        |        | RHR (DW10BTED4); Version (C2): 6 | <b>A2C59511601</b> | 11 |
|             |        |        |                                  | <b>A2C59513552</b> | 14 |
| 2.7 HDi     | 150 kW | 10/05→ | UHZ (DT17)                       | <b>A2C59511316</b> | 10 |

**Diesel common rail pump**

|             |        |        |                 |                    |    |
|-------------|--------|--------|-----------------|--------------------|----|
| 2.0 HDi     | 103 kW | 08/08→ | RHR (DW10BTED4) | <b>5WS40809-Z</b>  | 9  |
| 2.0 HDi 135 | 100 kW | 05/04→ |                 |                    |    |
| 2.7 HDi     | 150 kW | 10/05→ | UHZ (DT17)      | <b>A2C59511314</b> | 10 |

**PEUGEOT - 407 SW (6E\_) 05/04→**
**Diesel common rail piezo injector**

|             |        |        |                                  |                    |    |
|-------------|--------|--------|----------------------------------|--------------------|----|
| 2.0 HDi     | 103 kW | 08/08→ | RHR (DW10BTED4); Version (C2): 4 | <b>5WS40156-4Z</b> | 8  |
|             |        |        | RHR (DW10BTED4); Version (C2): 5 | <b>5WS40156-Z</b>  | 8  |
|             |        |        | RHR (DW10BTED4); Version (C2): 6 | <b>A2C59511601</b> | 11 |
| 2.0 HDi 135 | 100 kW | 05/04→ | RHR (DW10BTED4); Version (C2): 4 | <b>5WS40156-4Z</b> | 8  |
|             |        |        | RHR (DW10BTED4); Version (C2): 5 | <b>5WS40156-Z</b>  | 8  |
|             |        |        | RHR (DW10BTED4); Version (C2): 6 | <b>A2C59511601</b> | 11 |
|             |        |        |                                  | <b>A2C59513552</b> | 14 |
| 2.7 HDi     | 150 kW | 10/05→ | UHZ (DT17)                       | <b>A2C59511316</b> | 10 |

**Diesel common rail pump**

|             |        |        |                 |                    |    |
|-------------|--------|--------|-----------------|--------------------|----|
| 2.0 HDi     | 103 kW | 08/08→ | RHR (DW10BTED4) | <b>5WS40809-Z</b>  | 9  |
| 2.0 HDi 135 | 100 kW | 05/04→ |                 |                    |    |
| 2.7 HDi     | 150 kW | 10/05→ | UHZ (DT17)      | <b>A2C59511314</b> | 10 |

**PEUGEOT - 508 11/10→**
**Diesel common rail piezo injector**

|         |       |        |                           |                    |    |
|---------|-------|--------|---------------------------|--------------------|----|
| 1.6 HDi | 82 kW | 11/10→ | 9HR (DV6C);  03/10  12/11 | <b>A2C59513556</b> | 15 |
| 1.6 HDi | 84 kW | 02/12→ | 9HD (DV6CTED)             | <b>A2C59513556</b> | 15 |

**Diesel common rail pump**

|         |       |        |                       |                    |    |
|---------|-------|--------|-----------------------|--------------------|----|
| 1.6 HDi | 82 kW | 11/10→ | 9HR (DV6C);  07/10    | <b>A2C59513830</b> | 16 |
| 1.6 HDi | 84 kW | 02/12→ | 9HD (DV6CTED);  07/10 | <b>A2C59513830</b> | 16 |

**PEUGEOT - 508 SW 11/10→**
**Diesel common rail piezo injector**

|         |       |        |                           |                    |    |
|---------|-------|--------|---------------------------|--------------------|----|
| 1.6 HDi | 82 kW | 11/10→ | 9HR (DV6C);  03/10  12/11 | <b>A2C59513556</b> | 15 |
|         |       |        | 9HR (DV6C);  12/11        | <b>A2C59513556</b> | 15 |
| 1.6 HDi | 84 kW | 02/12→ | 9HD (DV6CTED)             | <b>A2C59513556</b> | 15 |

**Diesel common rail pump**

|         |       |        |                       |                    |    |
|---------|-------|--------|-----------------------|--------------------|----|
| 1.6 HDi | 82 kW | 11/10→ | 9HR (DV6C);  07/10    | <b>A2C59513830</b> | 16 |
| 1.6 HDi | 84 kW | 02/12→ | 9HD (DV6CTED);  07/10 | <b>A2C59513830</b> | 16 |

**PEUGEOT - 607 Saloon (9D, 9U) 12/04→**
**Diesel common rail piezo injector**

|             |        |        |                 |                    |    |
|-------------|--------|--------|-----------------|--------------------|----|
| 2.0 HDi     | 100 kW | 09/05→ | RHR (DW10BTED4) | <b>5WS40156-Z</b>  | 8  |
| 2.7 HDi 24V | 150 kW | 12/04→ | DT17TED4        | <b>A2C59511316</b> | 10 |

**Diesel common rail pump**

|             |        |        |                 |                    |    |
|-------------|--------|--------|-----------------|--------------------|----|
| 2.0 HDi     | 100 kW | 09/05→ | RHR (DW10BTED4) | <b>5WS40809-Z</b>  | 9  |
| 2.7 HDi 24V | 150 kW | 12/04→ | DT17TED4        | <b>A2C59511314</b> | 10 |



VDO

**PEUGEOT - 807 (E) 02/06→**

| Diesel common rail piezo injector |        |        |                                  |                |
|-----------------------------------|--------|--------|----------------------------------|----------------|
| 2.0 HDi                           | 88 kW  | 02/06→ |                                  | A2C59511602 11 |
| 2.0 HDi                           | 100 kW | 06/06→ | RHR (DW10BTED4); Version (C2): 4 | 5WS40156-4Z 8  |
|                                   |        |        | RHR (DW10BTED4); Version (C2): 5 | 5WS40156-Z 8   |
|                                   |        |        | RHR (DW10BTED4); Version (C2): 6 | A2C59511601 11 |

| Diesel common rail pump |        |        |                 |              |
|-------------------------|--------|--------|-----------------|--------------|
| 2.0 HDi                 | 88 kW  | 02/06→ |                 | 5WS40809-Z 9 |
| 2.0 HDi                 | 100 kW | 06/06→ | RHR (DW10BTED4) | 5WS40809-Z 9 |

**PEUGEOT - 1007 (KM\_) 04/05→**

| Diesel common rail piezo injector |       |        |             |                |
|-----------------------------------|-------|--------|-------------|----------------|
| 1.4 HDi                           | 50 kW | 04/05→ | 8HX (DV4TD) | 5WS40148-Z 7   |
|                                   |       |        | 8HZ (DV4TD) | A2C59511612 13 |

| Diesel common rail pump |       |        |             |              |
|-------------------------|-------|--------|-------------|--------------|
| 1.4 HDi                 | 50 kW | 04/05→ | 8HZ (DV4TD) | 5WS40008-Z 7 |

**PEUGEOT - 2008 03/13→**

| Diesel common rail piezo injector |       |        |               |                |
|-----------------------------------|-------|--------|---------------|----------------|
| 1.6 HDi                           | 84 kW | 03/13→ | 9HD (DV6CTED) | A2C59513556 15 |

| Diesel common rail pump |       |        |                       |                |
|-------------------------|-------|--------|-----------------------|----------------|
| 1.6 HDi                 | 84 kW | 03/13→ | 9HD (DV6CTED);  07/10 | A2C59513830 16 |

**PEUGEOT - 3008 06/09→**

| Diesel common rail piezo injector |       |        |                           |                |
|-----------------------------------|-------|--------|---------------------------|----------------|
| 1.6 HDi                           | 80 kW | 06/09→ | 9HZ (DV6TED4);  07/10     | A2C59513556 15 |
|                                   |       |        | 9HZ (DV6TED4);  06/10     | A2C59513556 15 |
| 1.6 HDi                           | 82 kW | 08/10→ | 9HR (DV6C);  03/10  12/11 | A2C59513556 15 |
|                                   |       |        | 9HR (DV6C);  12/11        | A2C59513556 15 |
| 1.6 HDi                           | 84 kW | 03/13→ | 9HD (DV6CTED)             | A2C59513556 15 |

| Diesel common rail pump |       |        |                       |                |
|-------------------------|-------|--------|-----------------------|----------------|
| 1.6 HDi                 | 80 kW | 06/09→ | 9HZ (DV6TED4);  07/10 | A2C59513830 16 |
|                         |       |        | 9HZ (DV6TED4);  06/10 | A2C59513830 16 |
| 1.6 HDi                 | 82 kW | 08/10→ | 9HR (DV6C);  07/10    | A2C59513830 16 |
| 1.6 HDi                 | 84 kW | 03/13→ | 9HD (DV6CTED);  07/10 | A2C59513830 16 |

**PEUGEOT - 4008 05/12→**

| Diesel common rail piezo injector |       |        |  |                |
|-----------------------------------|-------|--------|--|----------------|
| 1.6 HDi AWC                       | 84 kW | 05/12→ |  | A2C59513556 15 |

| Diesel common rail pump |       |        |       |                |
|-------------------------|-------|--------|-------|----------------|
| 1.6 HDi AWC             | 84 kW | 05/12→ | 07/10 | A2C59513830 16 |

**PEUGEOT - 5008 09/09→**

| Diesel common rail piezo injector |       |        |                           |                |
|-----------------------------------|-------|--------|---------------------------|----------------|
| 1.6 HDi                           | 80 kW | 09/09→ | 9HZ (DV6TED4);  07/10     | A2C59513556 15 |
|                                   |       |        | 9HZ (DV6TED4);  06/10     | A2C59513556 15 |
| 1.6 HDi                           | 82 kW | 08/10→ | 9HR (DV6C);  03/10  12/11 | A2C59513556 15 |
|                                   |       |        | 9HR (DV6C);  12/11        | A2C59513556 15 |
| 1.6 HDi                           | 84 kW | 03/13→ | 9HD (DV6CTED)             | A2C59513556 15 |

| Diesel common rail pump |       |        |                       |                |
|-------------------------|-------|--------|-----------------------|----------------|
| 1.6 HDi                 | 80 kW | 09/09→ | 9HZ (DV6TED4);  07/10 | A2C59513830 16 |
|                         |       |        | 9HZ (DV6TED4);  06/10 | A2C59513830 16 |
| 1.6 HDi                 | 82 kW | 08/10→ | 9HR (DV6C);  07/10    | A2C59513830 16 |
| 1.6 HDi                 | 84 kW | 03/13→ | 9HD (DV6CTED);  07/10 | A2C59513830 16 |



VDO

**PEUGEOT - BOXER Box 03/11→**

**Diesel common rail piezo injector**

|             |        |        |  |             |    |
|-------------|--------|--------|--|-------------|----|
| 2.2 HDi 110 | 81 kW  | 03/11→ |  | A2C59517051 | 18 |
| 2.2 HDi 130 | 96 kW  | 03/11→ |  |             |    |
| 2.2 HDi 150 | 110 kW | 03/11→ |  |             |    |

**Diesel common rail pump**

|             |        |        |  |             |    |
|-------------|--------|--------|--|-------------|----|
| 2.2 HDi 110 | 81 kW  | 03/11→ |  | A2C59517045 | 17 |
| 2.2 HDi 130 | 96 kW  | 03/11→ |  |             |    |
| 2.2 HDi 150 | 110 kW | 03/11→ |  |             |    |

**PEUGEOT - BOXER Bus 03/11→**

**Diesel common rail piezo injector**

|             |        |        |  |             |    |
|-------------|--------|--------|--|-------------|----|
| 2.2 HDi 110 | 81 kW  | 03/11→ |  | A2C59517051 | 18 |
| 2.2 HDi 130 | 96 kW  | 03/11→ |  |             |    |
| 2.2 HDi 150 | 110 kW | 03/11→ |  |             |    |

**Diesel common rail pump**

|             |        |        |  |             |    |
|-------------|--------|--------|--|-------------|----|
| 2.2 HDi 110 | 81 kW  | 03/11→ |  | A2C59517045 | 17 |
| 2.2 HDi 130 | 96 kW  | 03/11→ |  |             |    |
| 2.2 HDi 150 | 110 kW | 03/11→ |  |             |    |

**PEUGEOT - BOXER Platform/Chassis 03/11→**

**Diesel common rail piezo injector**

|             |        |        |  |             |    |
|-------------|--------|--------|--|-------------|----|
| 2.2 HDi 110 | 81 kW  | 03/11→ |  | A2C59517051 | 18 |
| 2.2 HDi 130 | 96 kW  | 03/11→ |  |             |    |
| 2.2 HDi 150 | 110 kW | 03/11→ |  |             |    |

**Diesel common rail pump**

|             |        |        |  |             |    |
|-------------|--------|--------|--|-------------|----|
| 2.2 HDi 110 | 81 kW  | 03/11→ |  | A2C59517045 | 17 |
| 2.2 HDi 130 | 96 kW  | 03/11→ |  |             |    |
| 2.2 HDi 150 | 110 kW | 03/11→ |  |             |    |

**PEUGEOT - EXPERT Box (VF3A\_, VF3U\_, VF3X\_) 01/07→**

**Diesel common rail piezo injector**

|             |        |        |                                    |             |    |
|-------------|--------|--------|------------------------------------|-------------|----|
| 2.0 HDi 120 | 88 kW  | 01/07→ |                                    | A2C59511602 | 11 |
| 2.0 HDi 140 | 100 kW | 01/07→ | ☞ RHR (DW10BTED4); Version (C2): 4 | 5WS40156-4Z | 8  |
|             |        |        | ☞ RHR (DW10BTED4); Version (C2): 5 | 5WS40156-Z  | 8  |
|             |        |        | ☞ RHR (DW10BTED4); Version (C2): 6 | A2C59511601 | 11 |

**Diesel common rail pump**

|             |        |        |                   |            |   |
|-------------|--------|--------|-------------------|------------|---|
| 2.0 HDi 120 | 88 kW  | 01/07→ |                   | 5WS40809-Z | 9 |
| 2.0 HDi 140 | 100 kW | 01/07→ | ☞ RHR (DW10BTED4) | 5WS40809-Z | 9 |

**PEUGEOT - EXPERT Platform/Chassis 01/07→**

**Diesel common rail piezo injector**

|             |        |        |                                    |             |    |
|-------------|--------|--------|------------------------------------|-------------|----|
| 2.0 HDi 120 | 88 kW  | 01/07→ |                                    | A2C59511602 | 11 |
| 2.0 HDi 140 | 100 kW | 01/07→ | ☞ RHR (DW10BTED4); Version (C2): 4 | 5WS40156-4Z | 8  |
|             |        |        | ☞ RHR (DW10BTED4); Version (C2): 5 | 5WS40156-Z  | 8  |
|             |        |        | ☞ RHR (DW10BTED4); Version (C2): 6 | A2C59511601 | 11 |

**Diesel common rail pump**

|             |        |        |                   |            |   |
|-------------|--------|--------|-------------------|------------|---|
| 2.0 HDi 120 | 88 kW  | 01/07→ |                   | 5WS40809-Z | 9 |
| 2.0 HDi 140 | 100 kW | 01/07→ | ☞ RHR (DW10BTED4) | 5WS40809-Z | 9 |

**PEUGEOT - EXPERT Tepee (VF3V\_) 01/07→**

**Diesel common rail piezo injector**

|                 |        |        |                                    |             |    |
|-----------------|--------|--------|------------------------------------|-------------|----|
| 2.0 HDi 120     | 88 kW  | 01/07→ |                                    | A2C59511602 | 11 |
| 2.0 HDi 120 4x4 | 88 kW  | 01/07→ |                                    |             |    |
| 2.0 HDi 140     | 100 kW | 01/07→ | ☞ RHR (DW10BTED4); Version (C2): 4 | 5WS40156-4Z | 8  |
|                 |        |        | ☞ RHR (DW10BTED4); Version (C2): 5 | 5WS40156-Z  | 8  |
|                 |        |        | ☞ RHR (DW10BTED4); Version (C2): 6 | A2C59511601 | 11 |



| <b>PEUGEOT - EXPERT Tepee (VF3V_) 01/07→</b>    |        |             |  |                 |       |  |  |             |  |    |  |
|---|--------|-------------|--|-----------------|-------|--|--|-------------|--|----|--|
| <b>Diesel common rail pump</b>                  |        |             |  |                 |       |  |  |             |  |    |  |
| 2.0 HDi 120                                     | 88 kW  | 01/07→      |  |                 |       |  |  | 5WS40809-Z  |  | 9  |  |
| 2.0 HDi 120 4x4                                 | 88 kW  | 01/07→      |  |                 |       |  |  |             |  |    |  |
| 2.0 HDi 140                                     | 100 kW | 01/07→      |  | RHR (DW10BTED4) |       |  |  | 5WS40809-Z  |  | 9  |  |
| <b>PEUGEOT - PARTNER Box 04/10→</b>             |        |             |  |                 |       |  |  |             |  |    |  |
| <b>Diesel common rail piezo injector</b>        |        |             |  |                 |       |  |  |             |  |    |  |
| 1.6 HDi   | 82 kW  | 08/10→      |  | 12/11           |       |  |  | A2C59513556 |  | 15 |  |
|   |        |             |  | 03/10 -         | 12/11 |  |  | A2C59513556 |  | 15 |  |
| 1.6 HDi   | 84 kW  | 03/13→      |  | 9HL (DV6C)      |       |  |  | A2C59513556 |  | 15 |  |
| 1.6 HDi 90                                      | 68 kW  | 04/10→      |  | 12/11           |       |  |  | A2C59513556 |  | 15 |  |
|   |        |             |  | 03/10 -         | 12/11 |  |  | A2C59513556 |  | 15 |  |
| <b>Diesel common rail pump</b>                  |        |             |  |                 |       |  |  |             |  |    |  |
| 1.6 HDi   | 82 kW  | 08/10→      |  | 07/10           |       |  |  | A2C59513830 |  | 16 |  |
| 1.6 HDi   | 84 kW  | 03/13→      |  | 9HL (DV6C);     | 07/10 |  |  | A2C59513830 |  | 16 |  |
| 1.6 HDi 90                                      | 68 kW  | 04/10→      |  | 07/10           |       |  |  | A2C59513830 |  | 16 |  |
| <b>PEUGEOT - PARTNER Box (5) 04/00→</b>         |        |             |  |                 |       |  |  |             |  |    |  |
| <b>Diesel common rail piezo injector</b>        |        |             |  |                 |       |  |  |             |  |    |  |
| 2.0 HDi   | 66 kW  | 04/00→      |  | RHY (DW10TD)    |       |  |  | 5WS40000-Z  |  | 7  |  |
| 2.0 HDi 4x4                                     | 66 kW  | 04/04→      |  |                 |       |  |  |             |  |    |  |
| <b>PEUGEOT - PARTNER Combispace (5F) 02/00→</b> |        |             |  |                 |       |  |  |             |  |    |  |
| <b>Diesel common rail piezo injector</b>        |        |             |  |                 |       |  |  |             |  |    |  |
| 2.0 HDi   | 66 kW  | 02/00→      |  | RHY (DW10TD)    |       |  |  | 5WS40000-Z  |  | 7  |  |
| 2.0 HDi 4x4                                     | 66 kW  | 04/04→08/05 |  |                 |       |  |  |             |  |    |  |
| <b>PEUGEOT - PARTNER Tepee 08/10→</b>           |        |             |  |                 |       |  |  |             |  |    |  |
| <b>Diesel common rail piezo injector</b>        |        |             |  |                 |       |  |  |             |  |    |  |
| 1.6 HDi   | 82 kW  | 08/10→      |  | 12/11           |       |  |  | A2C59513556 |  | 15 |  |
|   |        |             |  | 03/10 -         | 12/11 |  |  | A2C59513556 |  | 15 |  |
| 1.6 HDi   | 84 kW  | 03/13→      |  | 9HL (DV6C)      |       |  |  | A2C59513556 |  | 15 |  |
| <b>Diesel common rail pump</b>                  |        |             |  |                 |       |  |  |             |  |    |  |
| 1.6 HDi   | 82 kW  | 08/10→      |  | 07/10           |       |  |  | A2C59513830 |  | 16 |  |
| 1.6 HDi   | 84 kW  | 03/13→      |  | 9HL (DV6C);     | 07/10 |  |  | A2C59513830 |  | 16 |  |
| <b>RENAULT - CAPTUR 01/15→</b>                  |        |             |  |                 |       |  |  |             |  |    |  |
| <b>Diesel common rail piezo injector</b>        |        |             |  |                 |       |  |  |             |  |    |  |
| 1.5 dCi 110                                     | 81 kW  | 01/15→      |  | K9K 646         |       |  |  | A2C59507596 |  | 9  |  |
| <b>Diesel common rail pump</b>                  |        |             |  |                 |       |  |  |             |  |    |  |
| 1.5 dCi 110                                     | 81 kW  | 01/15→      |  | K9K 646         |       |  |  | A2C59507608 |  | 9  |  |
| <b>RENAULT - CLIO III (BR0/1, CR0/1) 06/05→</b> |        |             |  |                 |       |  |  |             |  |    |  |
| <b>Diesel common rail piezo injector</b>        |        |             |  |                 |       |  |  |             |  |    |  |
| 1.5 dCi (BR0H, CR0H)                            | 78 kW  | 06/05→      |  | K9K 764         |       |  |  | A2C59511606 |  | 12 |  |
|   |        |             |  | K9K 774         |       |  |  | A2C59513484 |  | 14 |  |
| 1.5 dCi (BR1C, CR1C)                            | 76 kW  | 06/05→      |  | K9K 772         |       |  |  | A2C59511606 |  | 12 |  |
| <b>Diesel common rail pump</b>                  |        |             |  |                 |       |  |  |             |  |    |  |
| 1.5 dCi (BR0H, CR0H)                            | 78 kW  | 06/05→      |  | K9K 764         |       |  |  | A2C59511605 |  | 12 |  |
|   |        |             |  | K9K 774         |       |  |  | A2C59513595 |  | 15 |  |
| 1.5 dCi (BR1C, CR1C)                            | 76 kW  | 06/05→      |  | K9K 772         |       |  |  | A2C59511605 |  | 12 |  |
| <b>RENAULT - CLIO Grandtour (KR0/1_) 02/08→</b> |        |             |  |                 |       |  |  |             |  |    |  |
| <b>Diesel common rail piezo injector</b>        |        |             |  |                 |       |  |  |             |  |    |  |
| 1.5 dCi   | 65 kW  | 08/10→      |  | K9K 772         |       |  |  | A2C59511606 |  | 12 |  |



VDO

**RENAULT - CLIO Grandtour (KR0/1\_) 02/08→**

**Diesel common rail piezo injector**

|                      |       |        |         |                    |    |
|----------------------|-------|--------|---------|--------------------|----|
| 1.5 dCi (KR0H)       | 78 kW | 02/08→ | K9K 764 | <b>A2C59511606</b> | 12 |
|                      |       |        | K9K 774 | <b>A2C59513484</b> | 14 |
| 1.5 dCi (KR1C, KR1N) | 76 kW | 02/08→ | K9K 772 | <b>A2C59511606</b> | 12 |

**Diesel common rail pump**

|                      |       |        |         |                    |    |
|----------------------|-------|--------|---------|--------------------|----|
| 1.5 dCi              | 65 kW | 08/10→ | K9K 772 | <b>A2C59511605</b> | 12 |
| 1.5 dCi (KR0H)       | 78 kW | 02/08→ | K9K 764 | <b>A2C59511605</b> | 12 |
|                      |       |        | K9K 774 | <b>A2C59513595</b> | 15 |
| 1.5 dCi (KR1C, KR1N) | 76 kW | 02/08→ | K9K 772 | <b>A2C59511605</b> | 12 |

**RENAULT - FLUENCE (L30\_) 02/10→**

**Diesel common rail piezo injector**

|                      |       |        |                   |                    |    |
|----------------------|-------|--------|-------------------|--------------------|----|
| 1.5 dCi              | 70 kW | 07/14→ | K9K 826           | <b>A2C59513484</b> | 14 |
| 1.5 dCi (L30B)       | 78 kW | 02/10→ | K9K 832           | <b>A2C59513484</b> | 14 |
| 1.5 dCi (L30D, L30L) | 81 kW | 02/10→ | K9K 836 / K9K 837 | <b>A2C59513484</b> | 14 |
|                      |       |        |                   | <b>A2C59513484</b> | 14 |

**Diesel common rail pump**

|                      |       |        |                   |                    |    |
|----------------------|-------|--------|-------------------|--------------------|----|
| 1.5 dCi              | 70 kW | 07/14→ | K9K 826           | <b>A2C59513595</b> | 15 |
| 1.5 dCi (L30B)       | 78 kW | 02/10→ | K9K 832           | <b>A2C59513595</b> | 15 |
| 1.5 dCi (L30D, L30L) | 81 kW | 02/10→ | K9K 837           | <b>A2C59513595</b> | 15 |
|                      |       |        | K9K 836 / K9K 837 | <b>A2C59513595</b> | 15 |

**RENAULT - GRAND SCÉNIC III (JZ0/1\_) 02/09→**

**Diesel common rail piezo injector**

|         |       |        |                   |                    |    |
|---------|-------|--------|-------------------|--------------------|----|
| 1.5 dCi | 70 kW | 11/10→ | K9K 846           | <b>A2C59513484</b> | 14 |
| 1.5 dCi | 78 kW | 02/09→ | K9K 832           | <b>A2C59513484</b> | 14 |
| 1.5 dCi | 81 kW | 04/09→ | K9K 636           | <b>A2C59507596</b> | 9  |
|         |       |        | K9K 836 / K9K 837 | <b>A2C59513484</b> | 14 |

**Diesel common rail pump**

|         |       |        |                   |                    |    |
|---------|-------|--------|-------------------|--------------------|----|
| 1.5 dCi | 70 kW | 11/10→ | K9K 846           | <b>A2C59513595</b> | 15 |
| 1.5 dCi | 78 kW | 02/09→ | K9K 832           | <b>A2C59513595</b> | 15 |
| 1.5 dCi | 81 kW | 04/09→ | K9K 636           | <b>A2C59507608</b> | 9  |
|         |       |        | K9K 836 / K9K 837 | <b>A2C59513595</b> | 15 |

**RENAULT - KADJAR 06/15→**

**Diesel common rail piezo injector**

|             |       |        |                   |                    |   |
|-------------|-------|--------|-------------------|--------------------|---|
| 1.5 dCi 110 | 81 kW | 06/15→ | K9K 646 / K9K 647 | <b>A2C59507596</b> | 9 |
|-------------|-------|--------|-------------------|--------------------|---|

**Diesel common rail pump**

|             |       |        |                   |                    |   |
|-------------|-------|--------|-------------------|--------------------|---|
| 1.5 dCi 110 | 81 kW | 06/15→ | K9K 646 / K9K 647 | <b>A2C59507608</b> | 9 |
|-------------|-------|--------|-------------------|--------------------|---|

**RENAULT - KANGOO / GRAND KANGOO (KW0/1\_) 02/08→**

**Diesel common rail piezo injector**

|                      |       |        |         |                    |    |
|----------------------|-------|--------|---------|--------------------|----|
| 1.5 dCi (KW0C, KW0F) | 76 kW | 02/08→ | K9K 806 | <b>A2C59511606</b> | 12 |
|                      |       |        | K9K 804 | <b>A2C59511606</b> | 12 |
| 1.5 dCi 110          | 80 kW | 09/10→ | K9K 804 | <b>A2C59511606</b> | 12 |
| 1.5 dCi 110          | 81 kW | 03/13→ | K9K 636 | <b>A2C59507596</b> | 9  |

**Diesel common rail pump**

|                      |       |        |         |                    |    |
|----------------------|-------|--------|---------|--------------------|----|
| 1.5 dCi (KW0C, KW0F) | 76 kW | 02/08→ | K9K 806 | <b>A2C59511605</b> | 12 |
|                      |       |        | K9K 804 | <b>A2C59511605</b> | 12 |
| 1.5 dCi 110          | 80 kW | 09/10→ | K9K 804 | <b>A2C59511605</b> | 12 |
| 1.5 dCi 110          | 81 kW | 03/13→ | K9K 636 | <b>A2C59507608</b> | 9  |

**RENAULT - KANGOO BE BOP (KW0/1\_) 02/09→**

**Diesel common rail piezo injector**

|         |       |        |         |                    |    |
|---------|-------|--------|---------|--------------------|----|
| 1.5 dCi | 80 kW | 06/09→ | K9K 804 | <b>A2C59511606</b> | 12 |
|---------|-------|--------|---------|--------------------|----|



|   |       |             |         | VDO                |    |
|---|-------|-------------|---------|--------------------|----|
| <b>RENAULT - KANGOO BE BOP (KW0/1_) 02/09→</b>                  |       |             |         |                    |    |
| <b>Diesel common rail piezo injector</b>                        |       |             |         |                    |    |
| 1.5 dCi (KW0F)  | 76 kW | 02/09→      | K9K 806 | <b>A2C59511606</b> | 12 |
| <b>Diesel common rail pump</b>                                  |       |             |         |                    |    |
| 1.5 dCi   | 80 kW | 06/09→      | K9K 804 | <b>A2C59511605</b> | 12 |
| 1.5 dCi (KW0F)  | 76 kW | 02/09→      | K9K 806 | <b>A2C59511605</b> | 12 |
| <b>RENAULT - KANGOO Express (FW0/1_) 02/08→</b>                 |       |             |         |                    |    |
| <b>Diesel common rail piezo injector</b>                        |       |             |         |                    |    |
| 1.5 dCi (FW0F)  | 76 kW | 02/08→      | K9K 806 | <b>A2C59511606</b> | 12 |
| 1.5 dCi 110   | 80 kW | 09/10→      | K9K 804 | <b>A2C59511606</b> | 12 |
| 1.5 dCi 110   | 81 kW | 09/13→      | K9K 636 | <b>A2C59507596</b> | 9  |
| <b>Diesel common rail pump</b>                                  |       |             |         |                    |    |
| 1.5 dCi (FW0F)  | 76 kW | 02/08→      | K9K 806 | <b>A2C59511605</b> | 12 |
| 1.5 dCi 110   | 80 kW | 09/10→      | K9K 804 | <b>A2C59511605</b> | 12 |
| 1.5 dCi 110   | 81 kW | 09/13→      | K9K 636 | <b>A2C59507608</b> | 9  |
| <b>RENAULT - LAGUNA III (BT0/1) 10/07→</b>                      |       |             |         |                    |    |
| <b>Diesel common rail piezo injector</b>                        |       |             |         |                    |    |
| 1.5 dCi (BT00, BT0A, BT0T, BT1J)                                | 81 kW | 10/07→      | K9K 780 | <b>A2C59511606</b> | 12 |
| <b>Diesel common rail pump</b>                                  |       |             |         |                    |    |
| 1.5 dCi (BT00, BT0A, BT0T, BT1J)                                | 81 kW | 10/07→      | K9K 780 | <b>A2C59511605</b> | 12 |
| <b>RENAULT - LAGUNA III Grandtour (KT0/1) 10/07→</b>            |       |             |         |                    |    |
| <b>Diesel common rail piezo injector</b>                        |       |             |         |                    |    |
| 1.5 dCi (KT0A)  | 81 kW | 10/07→      | K9K 780 | <b>A2C59511606</b> | 12 |
| <b>Diesel common rail pump</b>                                  |       |             |         |                    |    |
| 1.5 dCi (KT0A)  | 81 kW | 10/07→      | K9K 780 | <b>A2C59511605</b> | 12 |
| <b>RENAULT - LAGUNA Coupe (DT0/1) 03/12→</b>                    |       |             |         |                    |    |
| <b>Diesel common rail piezo injector</b>                        |       |             |         |                    |    |
| 1.5 dCi   | 81 kW | 03/12→      | K9K 846 | <b>A2C59513484</b> | 14 |
| <b>Diesel common rail pump</b>                                  |       |             |         |                    |    |
| 1.5 dCi   | 81 kW | 03/12→      | K9K 846 | <b>A2C59513595</b> | 15 |
| <b>RENAULT - LATITUDE (L70_) 07/10→</b>                         |       |             |         |                    |    |
| <b>Diesel common rail piezo injector</b>                        |       |             |         |                    |    |
| 1.5 dCi (L70R)  | 81 kW | 07/10→      | K9K 782 | <b>A2C59513484</b> | 14 |
| <b>Diesel common rail pump</b>                                  |       |             |         |                    |    |
| 1.5 dCi (L70R)  | 81 kW | 07/10→      | K9K 782 | <b>A2C59513595</b> | 15 |
| <b>RENAULT - MEGANE II (BM0/1_, CM0/1_) 05/05→06/08</b>         |       |             |         |                    |    |
| <b>Diesel common rail piezo injector</b>                        |       |             |         |                    |    |
| 1.5 dCi   | 76 kW | 01/07→02/08 | K9K 734 | <b>A2C59511606</b> | 12 |
| 1.5 dCi   | 78 kW | 05/05→06/08 |         |                    |    |
| <b>Diesel common rail pump</b>                                  |       |             |         |                    |    |
| 1.5 dCi   | 76 kW | 01/07→02/08 | K9K 734 | <b>A2C59511605</b> | 12 |
| 1.5 dCi   | 78 kW | 05/05→06/08 |         |                    |    |
| <b>RENAULT - MEGANE II Coupé-Cabriolet (EM0/1_) 01/07→06/09</b> |       |             |         |                    |    |
| <b>Diesel common rail piezo injector</b>                        |       |             |         |                    |    |
| 1.5 dCi (EM16)  | 76 kW | 01/07→06/09 | K9K 734 | <b>A2C59511606</b> | 12 |



| <b>RENAULT - MEGANE II Coupé-Cabriolet (EM0/1_) 01/07→06/09</b> |   |
|---|---|
| <b>Diesel common rail pump</b>                                  |   |
| 1.5 dCi (EM16)  | 76 kW 01/07→06/09  K9K 734 <b>A2C59511605</b> 12        |
| <b>RENAULT - MEGANE II Estate (KM0/1_) 05/05→06/08</b>          |   |
| <b>Diesel common rail piezo injector</b>                        |   |
| 1.5 dCi (KM16, KM1E)  | 78 kW 05/05→06/08  K9K 734 <b>A2C59511606</b> 12        |
| <b>Diesel common rail pump</b>                                  |   |
| 1.5 dCi (KM16, KM1E)  | 78 kW 05/05→06/08  K9K 734 <b>A2C59511605</b> 12        |
| <b>RENAULT - MEGANE II Saloon (LM0/1_) 01/07→</b>               |   |
| <b>Diesel common rail piezo injector</b>                        |   |
| 1.5 dCi   | 76 kW 01/07→  K9K 734 <b>A2C59511606</b> 12             |
| <b>Diesel common rail pump</b>                                  |   |
| 1.5 dCi   | 76 kW 01/07→  K9K 734 <b>A2C59511605</b> 12             |
| <b>RENAULT - MEGANE III Coupe (DZ0/1_) 02/09→</b>               |   |
| <b>Diesel common rail piezo injector</b>                        |   |
| 1.5 dCi   | 70 kW 07/14→  K9K 846 <b>A2C59513484</b> 14             |
| 1.5 dCi (DZ09, DZ0D, DZ1F, DZ1G)                                | 81 kW 02/09→  K9K J 836 / K9K 837 <b>A2C59513484</b> 14 |
| <b>Diesel common rail pump</b>                                  |   |
| 1.5 dCi   | 70 kW 07/14→  K9K 846 <b>A2C59513595</b> 15             |
| 1.5 dCi (DZ09, DZ0D, DZ1F, DZ1G)                                | 81 kW 02/09→  K9K J 836 / K9K 837 <b>A2C59513595</b> 15 |
| <b>RENAULT - MEGANE III Grandtour (KZ0/1) 02/09→</b>            |   |
| <b>Diesel common rail piezo injector</b>                        |   |
| 1.5 dCi   | 70 kW 11/13→  K9K 846 <b>A2C59513484</b> 14             |
| 1.5 dCi (KZ09, KZ0D, KZ1G, KZ1M, KZ1W)                          | 81 kW 02/09→  K9K 636 <b>A2C59507596</b> 9              |
|   | K9K 836 / K9K 837 / K9K 846 <b>A2C59513484</b> 14       |
| 1.5 dCi (KZ1M, KZ1W)  | 78 kW 02/09→  K9K 836 / K9K 846 <b>A2C59513484</b> 14   |
| <b>Diesel common rail pump</b>                                  |   |
| 1.5 dCi   | 70 kW 11/13→  K9K 846 <b>A2C59513595</b> 15             |
| 1.5 dCi (KZ09, KZ0D, KZ1G, KZ1M, KZ1W)                          | 81 kW 02/09→  K9K 636 <b>A2C59507608</b> 9              |
|   | K9K 836 / K9K 837 / K9K 846 <b>A2C59513595</b> 15       |
| 1.5 dCi (KZ1M, KZ1W)  | 78 kW 02/09→  K9K 836 / K9K 846 <b>A2C59513595</b> 15   |
| <b>RENAULT - MEGANE III Hatchback (BZ0_) 02/09→</b>             |   |
| <b>Diesel common rail piezo injector</b>                        |   |
| 1.5 dCi   | 70 kW 11/13→  K9K 846 <b>A2C59513484</b> 14             |
| 1.5 dCi (BZ09, BZ0D)  | 81 kW 02/09→  K9K 636 <b>A2C59507596</b> 9              |
|   | K9K 836 / K9K 837 / K9K 846 <b>A2C59513484</b> 14       |
| <b>Diesel common rail pump</b>                                  |   |
| 1.5 dCi   | 70 kW 11/13→  K9K 846 <b>A2C59513595</b> 15             |
| 1.5 dCi (BZ09, BZ0D)  | 81 kW 02/09→  K9K 636 <b>A2C59507608</b> 9              |
|   | K9K 836 / K9K 837 / K9K 846 <b>A2C59513595</b> 15       |
| <b>RENAULT - MEGANE CC (EZ0/1_) 06/10→</b>                      |   |
| <b>Diesel common rail piezo injector</b>                        |   |
| 1.5 dCi (EZ09, EZ1G, EZ0D)                                      | 81 kW 06/10→  K9K 836 <b>A2C59513484</b> 14             |
| <b>Diesel common rail pump</b>                                  |   |
| 1.5 dCi (EZ09, EZ1G, EZ0D)                                      | 81 kW 06/10→  K9K 836 <b>A2C59513595</b> 15             |



VDO

**RENAULT - MODUS / GRAND MODUS (F/JP0\_) 05/05→**

| Diesel common rail piezo injector |       |        |         |             |    |
|-----------------------------------|-------|--------|---------|-------------|----|
| 1.5 dCi (JP02)                    | 76 kW | 05/07→ | K9K 772 | A2C59511606 | 12 |
| 1.5 dCi (JP0G, JP0H)              | 78 kW | 05/05→ | K9K 764 | A2C59511606 | 12 |
| Diesel common rail pump           |       |        |         |             |    |
| 1.5 dCi (JP02)                    | 76 kW | 05/07→ | K9K 772 | A2C59511605 | 12 |
| 1.5 dCi (JP0G, JP0H)              | 78 kW | 05/05→ | K9K 764 | A2C59511605 | 12 |

**RENAULT - SCÉNIC II (JM0/1\_) 01/07→**

| Diesel common rail piezo injector |       |        |         |             |    |
|-----------------------------------|-------|--------|---------|-------------|----|
| 1.5 dCi (JM16)                    | 76 kW | 01/07→ | K9K 734 | A2C59511606 | 12 |
| Diesel common rail pump           |       |        |         |             |    |
| 1.5 dCi (JM16)                    | 76 kW | 01/07→ | K9K 734 | A2C59511605 | 12 |

**RENAULT - SCÉNIC III (JZ0/1\_) 02/09→**

| Diesel common rail piezo injector |       |        |                   |             |    |
|-----------------------------------|-------|--------|-------------------|-------------|----|
| 1.5 dCi                           | 70 kW | 11/10→ | K9K 846           | A2C59513484 | 14 |
| 1.5 dCi                           | 78 kW | 02/09→ | K9K 832           | A2C59513484 | 14 |
| 1.5 dCi                           | 81 kW | 04/09→ | K9K 636           | A2C59507596 | 9  |
|                                   |       |        | K9K 836 / K9K 837 | A2C59513484 | 14 |
| Diesel common rail pump           |       |        |                   |             |    |
| 1.5 dCi                           | 70 kW | 11/10→ | K9K 846           | A2C59513595 | 15 |
| 1.5 dCi                           | 78 kW | 02/09→ | K9K 832           | A2C59513595 | 15 |
| 1.5 dCi                           | 81 kW | 04/09→ | K9K 636           | A2C59507608 | 9  |
|                                   |       |        | K9K 836 / K9K 837 | A2C59513595 | 15 |

**SEAT - ALTEA (5P1) 10/09→**

| Diesel common rail piezo injector |       |        |      |             |    |
|-----------------------------------|-------|--------|------|-------------|----|
| 1.6 TDI                           | 66 kW | 11/10→ | CAYB | A2C59513554 | 15 |
| 1.6 TDI                           | 77 kW | 10/09→ | CAYC | A2C59513554 | 15 |
| Diesel common rail pump           |       |        |      |             |    |
| 1.6 TDI                           | 66 kW | 11/10→ | CAYB | A2C59517047 | 17 |

**SEAT - ALTEA XL (5P5, 5P8) 10/09→**

| Diesel common rail piezo injector |       |        |      |             |    |
|-----------------------------------|-------|--------|------|-------------|----|
| 1.6 TDI                           | 66 kW | 11/10→ | CAYB | A2C59513554 | 15 |
| 1.6 TDI                           | 77 kW | 10/09→ | CAYC | A2C59513554 | 15 |

**SEAT - IBIZA V (6J5, 6P1) 05/09→**

| Diesel common rail piezo injector |       |        |  |             |    |
|-----------------------------------|-------|--------|--|-------------|----|
| 1.6 TDI                           | 66 kW | 05/09→ | CAYB;  [XXXXXXXXXX] → 6J-9-000001        | A2C59513554 | 15 |
| 1.6 TDI                           | 77 kW | 05/09→ | CAYC / CLNA;  [XXXXXXXXXX] → 6J-9-000001 | A2C59513554 | 15 |
| Diesel common rail pump           |       |        |  |             |    |
| 1.6 TDI                           | 66 kW | 05/09→ | CAYB;  [XXXXXXXXXX] → 6J-9-000001        | A2C59517047 | 17 |
| 1.6 TDI                           | 77 kW | 05/09→ | CAYC;  [XXXXXXXXXX] → 6J-9-000001        | A2C59517047 | 17 |

**SEAT - IBIZA V SPORTCOUPE (6J1, 6P5) 05/09→**

| Diesel common rail piezo injector |       |        |  |             |    |
|-----------------------------------|-------|--------|--|-------------|----|
| 1.6 TDI                           | 66 kW | 05/09→ | CAYB;  [XXXXXXXXXX] → 6J-9-000001        | A2C59513554 | 15 |
| 1.6 TDI                           | 77 kW | 05/09→ | CLNA / CAYC;  [XXXXXXXXXX] → 6J-9-000001 | A2C59513554 | 15 |
| Diesel common rail pump           |       |        |  |             |    |
| 1.6 TDI                           | 66 kW | 05/09→ | CAYB;  [XXXXXXXXXX] → 6J-9-000001        | A2C59517047 | 17 |
| 1.6 TDI                           | 77 kW | 05/09→ | CAYC;  [XXXXXXXXXX] → 6J-9-000001        | A2C59517047 | 17 |





|  |       |             |  |                                   |  | VDO                |    |
|--|-------|-------------|--|-----------------------------------|--|--------------------|----|
| <b>SEAT - IBIZA V ST (6J8, 6P8) 03/10→</b>     |       |             |  |                                   |  |                    |    |
| <b>Diesel common rail piezo injector</b>       |       |             |  |                                   |  |                    |    |
| 1.6 TDI  | 66 kW | 03/10→      |  | CAYB;  → 6J-9-000001              |  | <b>A2C59513554</b> | 15 |
| 1.6 TDI  | 77 kW | 03/10→      |  | CAYC / CLNA;  → 6J-9-000001       |  | <b>A2C59513554</b> | 15 |
| <b>Diesel common rail pump</b>                 |       |             |  |                                   |  |                    |    |
| 1.6 TDI  | 66 kW | 03/10→      |  | CAYB;  → 6J-9-000001              |  | <b>A2C59517047</b> | 17 |
| 1.6 TDI  | 77 kW | 03/10→      |  | CAYC;  → 6J-9-000001              |  | <b>A2C59517047</b> | 17 |
| <b>SEAT - LEON (1P1) 02/10→12/12</b>           |       |             |  |                                   |  |                    |    |
| <b>Diesel common rail piezo injector</b>       |       |             |  |                                   |  |                    |    |
| 1.6 TDI  | 66 kW | 11/10→12/12 |  | CAYB                              |  | <b>A2C59513554</b> | 15 |
| 1.6 TDI  | 77 kW | 02/10→12/12 |  | CAYC                              |  | <b>A2C59513554</b> | 15 |
| <b>Diesel common rail pump</b>                 |       |             |  |                                   |  |                    |    |
| 1.6 TDI  | 66 kW | 11/10→12/12 |  | CAYB                              |  | <b>A2C59517047</b> | 17 |
| 1.6 TDI  | 77 kW | 02/10→12/12 |  | CAYC                              |  | <b>A2C59517047</b> | 17 |
| <b>SEAT - TOLEDO IV (KG3) 07/12→</b>           |       |             |  |                                   |  |                    |    |
| <b>Diesel common rail piezo injector</b>       |       |             |  |                                   |  |                    |    |
| 1.6 TDI  | 66 kW | 06/13→      |  | CAYB                              |  | <b>A2C59513554</b> | 15 |
| 1.6 TDI  | 77 kW | 07/12→      |  | CLNA                              |  | <b>A2C59513554</b> | 15 |
|  |       |             |  | CAYC                              |  | <b>A2C59513554</b> | 15 |
| <b>Diesel common rail pump</b>                 |       |             |  |                                   |  |                    |    |
| 1.6 TDI  | 66 kW | 06/13→      |  | CAYB; Model year to (C21): 2015   |  | <b>A2C59517047</b> | 17 |
| <b>SKODA - FABIA 03/10→12/14</b>               |       |             |  |                                   |  |                    |    |
| <b>Diesel common rail piezo injector</b>       |       |             |  |                                   |  |                    |    |
| 1.6 TDI  | 55 kW | 04/10→12/14 |  | CAYA; Model year from (C20): 2011 |  | <b>A2C59513554</b> | 15 |
| 1.6 TDI  | 66 kW | 03/10→12/14 |  | CAYB; Model year from (C20): 2011 |  | <b>A2C59513554</b> | 15 |
| 1.6 TDI  | 77 kW | 03/10→12/14 |  | CAYC; Model year from (C20): 2011 |  | <b>A2C59513554</b> | 15 |
| <b>Diesel common rail pump</b>                 |       |             |  |                                   |  |                    |    |
| 1.6 TDI  | 55 kW | 04/10→12/14 |  | CAYA                              |  | <b>A2C59517047</b> | 17 |
| 1.6 TDI  | 66 kW | 03/10→12/14 |  | CAYB                              |  | <b>A2C59517047</b> | 17 |
| 1.6 TDI  | 77 kW | 03/10→12/14 |  | CAYC                              |  | <b>A2C59517047</b> | 17 |
| <b>SKODA - FABIA Combi 03/10→12/14</b>         |       |             |  |                                   |  |                    |    |
| <b>Diesel common rail piezo injector</b>       |       |             |  |                                   |  |                    |    |
| 1.6 TDI  | 55 kW | 04/10→12/14 |  | CAYA; Model year from (C20): 2011 |  | <b>A2C59513554</b> | 15 |
| 1.6 TDI  | 66 kW | 03/10→12/14 |  | CAYB; Model year from (C20): 2011 |  | <b>A2C59513554</b> | 15 |
| 1.6 TDI  | 77 kW | 03/10→12/14 |  | CAYC; Model year from (C20): 2011 |  | <b>A2C59513554</b> | 15 |
| <b>SKODA - OCTAVIA (1Z3) 06/09→04/13</b>       |       |             |  |                                   |  |                    |    |
| <b>Diesel common rail piezo injector</b>       |       |             |  |                                   |  |                    |    |
| 1.6 TDI  | 77 kW | 06/09→04/13 |  | CAYC                              |  | <b>A2C59513554</b> | 15 |
| <b>Diesel common rail pump</b>                 |       |             |  |                                   |  |                    |    |
| 1.6 TDI  | 77 kW | 06/09→04/13 |  | CAYC;  → 1Z-9-000001              |  | <b>A2C59517047</b> | 17 |
| <b>SKODA - OCTAVIA Combi (1Z5) 06/09→04/13</b> |       |             |  |                                   |  |                    |    |
| <b>Diesel common rail piezo injector</b>       |       |             |  |                                   |  |                    |    |
| 1.6 TDI  | 77 kW | 06/09→04/13 |  | CAYC                              |  | <b>A2C59513554</b> | 15 |
| 1.6 TDI 4x4                                    | 77 kW | 06/09→02/13 |  |                                   |  |                    |    |
| <b>Diesel common rail pump</b>                 |       |             |  |                                   |  |                    |    |
| 1.6 TDI  | 77 kW | 06/09→04/13 |  | CAYC;  → 1Z-9-000001              |  | <b>A2C59517047</b> | 17 |
| 1.6 TDI 4x4                                    | 77 kW | 06/09→02/13 |  |                                   |  |                    |    |



|  |        |             |  |   | VDO         |    |
|--|--------|-------------|--|---|-------------|----|
| <b>SKODA - RAPID (NH3) 07/12→</b>                |        |             |  |   |             |    |
| <b>Diesel common rail piezo injector</b>         |        |             |  |   |             |    |
| 1.6 TDI  | 66 kW  | 08/13→      |  | CAYB  | A2C59513554 | 15 |
| 1.6 TDI  | 77 kW  | 07/12→      |  | CAYC  | A2C59513554 | 15 |
| <b>Diesel common rail pump</b>                   |        |             |  |   |             |    |
| 1.6 TDI  | 66 kW  | 08/13→      |  | CAYB  | A2C59517047 | 17 |
| 1.6 TDI  | 77 kW  | 07/12→      |  | CLNA  | A2C59517049 | 18 |
| <b>SKODA - RAPID Spaceback (NH1) 07/12→</b>      |        |             |  |   |             |    |
| <b>Diesel common rail piezo injector</b>         |        |             |  |   |             |    |
| 1.6 TDI  | 66 kW  | 08/13→      |  | CAYB  | A2C59513554 | 15 |
| 1.6 TDI  | 77 kW  | 07/12→      |  | CLNA  | A2C59513554 | 15 |
| <b>Diesel common rail pump</b>                   |        |             |  |   |             |    |
| 1.6 TDI  | 66 kW  | 08/13→      |  | CAYB  | A2C59517047 | 17 |
| 1.6 TDI  | 77 kW  | 07/12→      |  | CLNA  | A2C59517049 | 18 |
| <b>SKODA - ROOMSTER (5J) 03/10→05/15</b>         |        |             |  |   |             |    |
| <b>Diesel common rail piezo injector</b>         |        |             |  |   |             |    |
| 1.6 TDI  | 66 kW  | 03/10→05/15 |  | CAYB  | A2C59513554 | 15 |
| 1.6 TDI  | 77 kW  | 03/10→05/15 |  | CAYC  | A2C59513554 | 15 |
| <b>SKODA - ROOMSTER Praktik (5J) 03/10→05/15</b> |        |             |  |   |             |    |
| <b>Diesel common rail piezo injector</b>         |        |             |  |   |             |    |
| 1.6 TDI  | 66 kW  | 03/10→05/15 |  | CAYB  | A2C59513554 | 15 |
| <b>SKODA - SUPERB (3T4) 09/10→05/15</b>          |        |             |  |   |             |    |
| <b>Diesel common rail piezo injector</b>         |        |             |  |   |             |    |
| 1.6 TDI  | 77 kW  | 09/10→05/15 |  | CAYC;  → 3T-8-000001                                  | A2C59513554 | 15 |
| <b>Diesel common rail pump</b>                   |        |             |  |   |             |    |
| 1.6 TDI  | 77 kW  | 09/10→05/15 |  | CAYC; Model year from (C20): 2014                     | A2C59517047 | 17 |
| <b>SKODA - SUPERB Estate (3T5) 09/10→05/15</b>   |        |             |  |   |             |    |
| <b>Diesel common rail piezo injector</b>         |        |             |  |   |             |    |
| 1.6 TDI  | 77 kW  | 09/10→05/15 |  | CAYC;  → 3T-8-000001                                  | A2C59513554 | 15 |
| <b>SKODA - YETI (5L) 11/10→</b>                  |        |             |  |   |             |    |
| <b>Diesel common rail piezo injector</b>         |        |             |  |   |             |    |
| 1.6 TDI  | 77 kW  | 11/10→      |  | CAYC  | A2C59513554 | 15 |
| <b>Diesel common rail pump</b>                   |        |             |  |   |             |    |
| 1.6 TDI  | 77 kW  | 11/10→      |  | CAYC;  → 03L130755AL ;<br>Model year from (C20): 2014 | A2C59517047 | 17 |
| <b>TOYOTA - AYGO (WNB1_, KGB1_) 07/05→08/10</b>  |        |             |  |   |             |    |
| <b>Diesel common rail piezo injector</b>         |        |             |  |   |             |    |
| 1.4 HDi (WNB10)                                  | 40 kW  | 07/05→08/10 |  | 2WZ-TV  | A2C59511612 | 13 |
| <b>Diesel common rail pump</b>                   |        |             |  |   |             |    |
| 1.4 HDi (WNB10)                                  | 40 kW  | 07/05→08/10 |  | 2WZTV   | 5WS40008-Z  | 7  |
| <b>VOLVO - C30 10/06→12/12</b>                   |        |             |  |   |             |    |
| <b>Diesel common rail piezo injector</b>         |        |             |  |   |             |    |
| 1.6 D2   | 84 kW  | 10/10→12/12 |  | D 4162 T  | A2C59513556 | 15 |
| 2.0 D  | 100 kW | 10/06→12/12 |  | D 4204 T; Version (C2): 4                             | 5WS40156-4Z | 8  |
|  |        |             |  | D 4204 T; Version (C2): 5                             | 5WS40156-Z  | 8  |



VDO

**VOLVO - C30 10/06→12/12****Diesel common rail pump**

|        |        |             |          |                    |    |
|--------|--------|-------------|----------|--------------------|----|
| 1.6 D2 | 84 kW  | 10/10→12/12 | D 4162 T | <b>A2C59513829</b> | 16 |
| 2.0 D  | 100 kW | 10/06→12/12 | D 4204 T | <b>A2C59511600</b> | 11 |

**VOLVO - C70 II Convertible 01/08→10/09****Diesel common rail piezo injector**

|       |        |             |                           |                    |   |
|-------|--------|-------------|---------------------------|--------------------|---|
| 2.0 D | 100 kW | 01/08→10/09 | D 4204 T; Version (C2): 4 | <b>5WS40156-4Z</b> | 8 |
|       |        |             | D 4204 T; Version (C2): 5 | <b>5WS40156-Z</b>  | 8 |

**Diesel common rail pump**

|       |        |             |          |                    |    |
|-------|--------|-------------|----------|--------------------|----|
| 2.0 D | 100 kW | 01/08→10/09 | D 4204 T | <b>A2C59511600</b> | 11 |
|-------|--------|-------------|----------|--------------------|----|

**VOLVO - S40 II Saloon (MS) 01/04→****Diesel common rail piezo injector**

|        |        |        |                            |                    |    |
|--------|--------|--------|----------------------------|--------------------|----|
| 1.6 D2 | 84 kW  | 10/10→ | D 4162 T                   | <b>A2C59513556</b> | 15 |
| 2.0 D  | 100 kW | 01/04→ | D 4204 T; Version (C2): 4  | <b>5WS40156-4Z</b> | 8  |
|        |        |        | D 4204 T; Version (C2): 5  | <b>5WS40156-Z</b>  | 8  |
| 2.0 D4 | 96 kW  | 07/05→ | D 4204 T2; Version (C2): 4 | <b>5WS40156-4Z</b> | 8  |
|        |        |        | D 4204 T2; Version (C2): 5 | <b>5WS40156-Z</b>  | 8  |

**Diesel common rail pump**

|        |        |        |           |                    |    |
|--------|--------|--------|-----------|--------------------|----|
| 1.6 D2 | 84 kW  | 10/10→ | D 4162 T  | <b>A2C59513829</b> | 16 |
| 2.0 D  | 100 kW | 01/04→ | D 4204 T  | <b>A2C59511600</b> | 11 |
| 2.0 D4 | 96 kW  | 07/05→ | D 4204 T2 | <b>A2C59511600</b> | 11 |

**VOLVO - S60 II 01/11→****Diesel common rail piezo injector**

|            |       |        |          |                    |    |
|------------|-------|--------|----------|--------------------|----|
| DRIVE / D2 | 84 kW | 01/11→ | D 4162 T | <b>A2C59513556</b> | 15 |
|------------|-------|--------|----------|--------------------|----|

**Diesel common rail pump**

|            |       |        |          |                    |    |
|------------|-------|--------|----------|--------------------|----|
| DRIVE / D2 | 84 kW | 01/11→ | D 4162 T | <b>A2C59513829</b> | 16 |
|------------|-------|--------|----------|--------------------|----|

**VOLVO - S80 II Saloon (AS) 02/08→****Diesel common rail piezo injector**

|           |        |        |                           |                    |    |
|-----------|--------|--------|---------------------------|--------------------|----|
| 1.6 DRIVE | 84 kW  | 06/11→ | D 4162 T                  | <b>A2C59513556</b> | 15 |
| 2.0 TDi   | 100 kW | 02/08→ | D 4204 T; Version (C2): 4 | <b>5WS40156-4Z</b> | 8  |
|           |        |        | D 4204 T; Version (C2): 5 | <b>5WS40156-Z</b>  | 8  |

**Diesel common rail pump**

|           |        |        |          |                    |    |
|-----------|--------|--------|----------|--------------------|----|
| 1.6 DRIVE | 84 kW  | 06/11→ | D 4162 T | <b>A2C59513829</b> | 16 |
| 2.0 TDi   | 100 kW | 02/08→ | D 4204 T | <b>A2C59511600</b> | 11 |

**VOLVO - V40 Hatchback 03/12→****Diesel common rail piezo injector**

|    |       |        |          |                    |    |
|----|-------|--------|----------|--------------------|----|
| D2 | 84 kW | 03/12→ | D 4162 T | <b>A2C59513556</b> | 15 |
|----|-------|--------|----------|--------------------|----|

**Diesel common rail pump**

|    |       |        |          |                    |    |
|----|-------|--------|----------|--------------------|----|
| D2 | 84 kW | 03/12→ | D 4162 T | <b>A2C59513829</b> | 16 |
|----|-------|--------|----------|--------------------|----|

**VOLVO - V50 Estate (MW) 04/04→****Diesel common rail piezo injector**

|        |        |        |                           |                    |    |
|--------|--------|--------|---------------------------|--------------------|----|
| 1.6 D2 | 84 kW  | 01/10→ | D 4162 T                  | <b>A2C59513556</b> | 15 |
| 2.0 D  | 100 kW | 04/04→ | D 4204 T; Version (C2): 4 | <b>5WS40156-4Z</b> | 8  |
|        |        |        | D 4204 T; Version (C2): 5 | <b>5WS40156-Z</b>  | 8  |

**Diesel common rail pump**

|        |        |        |          |                    |    |
|--------|--------|--------|----------|--------------------|----|
| 1.6 D2 | 84 kW  | 01/10→ | D 4162 T | <b>A2C59513829</b> | 16 |
| 2.0 D  | 100 kW | 04/04→ | D 4204 T | <b>A2C59511600</b> | 11 |



|  |        |             |                                   |  | VDO                |    |
|--|--------|-------------|-----------------------------------|--|--------------------|----|
| <b>VOLVO - V60 06/11→</b>                                |        |             |                                   |  |                    |    |
| <b>Diesel common rail piezo injector</b>                 |        |             |                                   |  |                    |    |
| 1.6 DRIVe  | 84 kW  | 06/11→      | D 4162 T                          |  | <b>A2C59513556</b> | 15 |
| <b>Diesel common rail pump</b>                           |        |             |                                   |  |                    |    |
| 1.6 DRIVe  | 84 kW  | 06/11→      | D 4162 T                          |  | <b>A2C59513829</b> | 16 |
| <b>VOLVO - V70 III (BW) 10/07→</b>                       |        |             |                                   |  |                    |    |
| <b>Diesel common rail piezo injector</b>                 |        |             |                                   |  |                    |    |
| 1.6 DRIVe / D2   | 84 kW  | 06/11→      | D 4162 T                          |  | <b>A2C59513556</b> | 15 |
| 2.0 D  | 100 kW | 10/07→      | D 4204 T; Version (C2): 4         |  | <b>5WS40156-4Z</b> | 8  |
|  |        |             | D 4204 T; Version (C2): 5         |  | <b>5WS40156-Z</b>  | 8  |
| <b>Diesel common rail pump</b>                           |        |             |                                   |  |                    |    |
| 1.6 DRIVe / D2   | 84 kW  | 06/11→      | D 4162 T                          |  | <b>A2C59513829</b> | 16 |
| 2.0 D  | 100 kW | 10/07→      | D 4204 T                          |  | <b>A2C59511600</b> | 11 |
| <b>VW - BEETLE (5C1) 10/11→</b>                          |        |             |                                   |  |                    |    |
| <b>Diesel common rail piezo injector</b>                 |        |             |                                   |  |                    |    |
| 1.6 TDI  | 77 kW  | 10/11→      | CAYC                              |  | <b>A2C59513554</b> | 15 |
| <b>Diesel common rail pump</b>                           |        |             |                                   |  |                    |    |
| 1.6 TDI  | 77 kW  | 10/11→      |                                   |  | <b>A2C59517047</b> | 17 |
| <b>VW - BEETLE Convertible (5C7) 12/11→</b>              |        |             |                                   |  |                    |    |
| <b>Diesel common rail piezo injector</b>                 |        |             |                                   |  |                    |    |
| 1.6 TDI  | 77 kW  | 12/11→      | CAYC                              |  | <b>A2C59513554</b> | 15 |
| <b>Diesel common rail pump</b>                           |        |             |                                   |  |                    |    |
| 1.6 TDI  | 77 kW  | 12/11→      | CAYC; Model year from (C20): 2013 |  | <b>A2C59517047</b> | 17 |
| <b>VW - CADDY III Box (2KA, 2KH, 2CA, 2CH) 08/10→</b>    |        |             |                                   |  |                    |    |
| <b>Diesel common rail pump</b>                           |        |             |                                   |  |                    |    |
| 1.6 TDI  | 55 kW  | 08/10→      | CAYE;   → 2K-B-200001             |  | <b>A2C59517047</b> | 17 |
| 1.6 TDI  | 75 kW  | 08/10→      | CAYD;   → 2K-B-200001             |  | <b>A2C59517047</b> | 17 |
| <b>VW - CADDY III Estate (2KB, 2KJ, 2CB, 2CJ) 08/10→</b> |        |             |                                   |  |                    |    |
| <b>Diesel common rail pump</b>                           |        |             |                                   |  |                    |    |
| 1.6 TDI  | 55 kW  | 08/10→      | CAYE;   → 2K-B-200001             |  | <b>A2C59517047</b> | 17 |
| 1.6 TDI  | 75 kW  | 08/10→      | CAYD;   → 2K-B-200001             |  | <b>A2C59517047</b> | 17 |
| <b>VW - CADDY IV Box (SAA, SAH) 05/15→</b>               |        |             |                                   |  |                    |    |
| <b>Diesel common rail pump</b>                           |        |             |                                   |  |                    |    |
| 1.6 TDI  | 55 kW  | 05/15→      | CAYE                              |  | <b>A2C59517047</b> | 17 |
| 1.6 TDI  | 75 kW  | 05/15→      | CAYD                              |  | <b>A2C59517047</b> | 17 |
| <b>VW - CADDY IV Estate (SAB, SAJ) 05/15→</b>            |        |             |                                   |  |                    |    |
| <b>Diesel common rail pump</b>                           |        |             |                                   |  |                    |    |
| 1.6 TDI  | 55 kW  | 05/15→      | CAYE                              |  | <b>A2C59517047</b> | 17 |
| 1.6 TDI  | 75 kW  | 05/15→      | CAYD                              |  | <b>A2C59517047</b> | 17 |
| <b>VW - GOLF VI (5K1) 02/09→11/12</b>                    |        |             |                                   |  |                    |    |
| <b>Diesel common rail piezo injector</b>                 |        |             |                                   |  |                    |    |
| 1.6 TDI  | 66 kW  | 02/09→11/12 | CAYB                              |  | <b>A2C59513554</b> | 15 |
| 1.6 TDI  | 77 kW  | 02/09→11/12 | CAYC                              |  | <b>A2C59513554</b> | 15 |
| <b>VW - GOLF VI Convertible (517) 03/11→</b>             |        |             |                                   |  |                    |    |
| <b>Diesel common rail piezo injector</b>                 |        |             |                                   |  |                    |    |
| 1.6 TDI  | 77 kW  | 03/11→      | CAYC                              |  | <b>A2C59513554</b> | 15 |



| <b>VW - GOLF VI Convertible (517) 03/11→</b>  |  |
|---|--|
| <b>Diesel common rail pump</b>                |  |
| 1.6 TDI                                       | 77 kW 03/11→  CAYC <b>A2C59517047</b> 17                                   |
| <b>VW - GOLF VI Variant (AJ5) 07/09→07/13</b> |  |
| <b>Diesel common rail piezo injector</b>      |  |
| 1.6 TDI                                       | 66 kW 12/09→07/13  CAYB <b>A2C59513554</b> 15                              |
| 1.6 TDI                                       | 77 kW 07/09→07/13  CAYC <b>A2C59513554</b> 15                              |
| 1.6 TDI 4motion                               | 77 kW 07/09→07/13  CAYC; <b>A2C59513554</b> 15                             |
| <b>Diesel common rail pump</b>                |  |
| 1.6 TDI                                       | 66 kW 12/09→07/13  CAYB <b>A2C59517047</b> 17                              |
| 1.6 TDI                                       | 77 kW 07/09→07/13  CAYC <b>A2C59517047</b> 17                              |
| 1.6 TDI 4motion                               | 77 kW 07/09→07/13  |
| <b>VW - GOLF PLUS (5M1, 521) 02/09→12/13</b>  |  |
| <b>Diesel common rail piezo injector</b>      |  |
| 1.6 TDI                                       | 66 kW 02/09→12/13  CAYB; <b>A2C59513554</b> 15                             |
| 1.6 TDI                                       | 77 kW 03/09→12/13  CAYC; <b>A2C59513554</b> 15                             |
| <b>Diesel common rail pump</b>                |  |
| 1.6 TDI                                       | 66 kW 02/09→12/13  CAYB; Model year from (C20): 2012 <b>A2C59517047</b> 17 |
| 1.6 TDI                                       | 77 kW 03/09→12/13  CAYC; Model year from (C20): 2012 <b>A2C59517047</b> 17 |
| <b>VW - JETTA I Saloon (1K2) 06/09→10/10</b>  |  |
| <b>Diesel common rail piezo injector</b>      |  |
| 1.6 TDI                                       | 66 kW 12/09→10/10  CAYB <b>A2C59513554</b> 15                              |
| 1.6 TDI                                       | 77 kW 06/09→10/10  CAYC <b>A2C59513554</b> 15                              |
| <b>Diesel common rail pump</b>                |  |
| 1.6 TDI                                       | 66 kW 12/09→10/10  CAYB <b>A2C59517047</b> 17                              |
| 1.6 TDI                                       | 77 kW 06/09→10/10  CAYC <b>A2C59517047</b> 17                              |
| <b>VW - JETTA IV (162, 163) 02/11→</b>        |  |
| <b>Diesel common rail piezo injector</b>      |  |
| 1.6 TDI                                       | 77 kW 02/11→  CAYC; <b>A2C59513554</b> 15                                  |
| <b>Diesel common rail pump</b>                |  |
| 1.6 TDI                                       | 77 kW 02/11→  CAYC; <b>A2C59517047</b> 17                                  |
| <b>VW - PASSAT (362) 08/10→12/14</b>          |  |
| <b>Diesel common rail piezo injector</b>      |  |
| 1.6 TDI                                       | 77 kW 08/10→12/14  CAYC; <b>A2C59513554</b> 15                             |
| <b>Diesel common rail pump</b>                |  |
| 1.6 TDI                                       | 77 kW 08/10→12/14  CAYC; <b>A2C59517049</b> 18                             |
| <b>VW - PASSAT Saloon (3C2) 08/09→07/10</b>   |  |
| <b>Diesel common rail piezo injector</b>      |  |
| 1.6 TDI                                       | 77 kW 08/09→07/10  CAYC <b>A2C59513554</b> 15                              |
| <b>VW - PASSAT Variant (3C5) 08/09→11/10</b>  |  |
| <b>Diesel common rail piezo injector</b>      |  |
| 1.6 TDI                                       | 77 kW 08/09→11/10  CAYC <b>A2C59513554</b> 15                              |
| <b>Diesel common rail pump</b>                |  |
| 1.6 TDI                                       | 77 kW 08/09→11/10  CAYC <b>A2C59517047</b> 17                              |



|  |       |             |   | VDO                |    |
|--|-------|-------------|---|--------------------|----|
| <b>VW - PASSAT Variant (365) 08/10→12/14</b> |       |             |   |                    |    |
| <b>Diesel common rail piezo injector</b>     |       |             |   |                    |    |
| 1.6 TDI                                      | 77 kW | 08/10→12/14 | CAYC;  → 3C-B-200001  | <b>A2C59513554</b> | 15 |
| <b>Diesel common rail pump</b>               |       |             |   |                    |    |
| 1.6 TDI                                      | 77 kW | 08/10→12/14 | CAYC;  → 3C-B-200001  | <b>A2C59517049</b> | 18 |
| <b>VW - POLO (6R, 6C) 06/09→</b>             |       |             |   |                    |    |
| <b>Diesel common rail piezo injector</b>     |       |             |   |                    |    |
| 1.6 TDI                                      | 55 kW | 06/09→      | CAYA;  → 6R-A-000 001   | <b>A2C59513554</b> | 15 |
| 1.6 TDI                                      | 66 kW | 06/09→      | CAYB;  → 60-AT000 001 / 6R-D-000 001  | <b>A2C59513554</b> | 15 |
| 1.6 TDI                                      | 77 kW | 06/09→      | CLNA;<br>→ 6R-A-000 001 / 60-AT000 001 / 6R-D-000 001 / 60-FT000 001 ;  01/16 | <b>A2C59513554</b> | 15 |
|  |       |             | CAYC;  → 60-AT000 001 / 6R-D-000 001  | <b>A2C59513554</b> | 15 |
| <b>Diesel common rail pump</b>               |       |             |   |                    |    |
| 1.6 TDI                                      | 55 kW | 06/09→      | CAYA; Model year from (C20): 2013 Model year to (C21): 2014;  → 6R-D-000001   | <b>A2C59517047</b> | 17 |
| 1.6 TDI                                      | 66 kW | 06/09→      | CAYB; Model year from (C20): 2013 Model year to (C21): 2014;  → 6R-D-000001   | <b>A2C59517047</b> | 17 |
| <b>VW - TOURAN (1T3) 05/10→05/15</b>         |       |             |   |                    |    |
| <b>Diesel common rail piezo injector</b>     |       |             |   |                    |    |
| 1.6 TDI                                      | 66 kW | 05/10→05/15 | CAYB; Model year from (C20): 2011   | <b>A2C59513554</b> | 15 |
| 1.6 TDI                                      | 77 kW | 05/10→05/15 | CAYC; Model year from (C20): 2011   | <b>A2C59513554</b> | 15 |
| <b>Diesel common rail pump</b>               |       |             |   |                    |    |
| 1.6 TDI                                      | 66 kW | 05/10→05/15 | CAYB; Model year from (C20): 2011 Model year to (C21): 2015                   | <b>A2C59517047</b> | 17 |
| 1.6 TDI                                      | 77 kW | 05/10→05/15 | CAYC; Model year from (C20): 2011 Model year to (C21): 2015                   | <b>A2C59517047</b> | 17 |



## Cross-Reference List

Referenzliste

Liste de référence

Lista de referencia

Lista di referenze

Список Литературы

































































| Article-No. | OE-No./Ref.-No. | Manufacturer | Product name                      |
|-------------|-----------------|--------------|-----------------------------------|
| 5WS40000-Z  | 00001980F0      | CITROËN      | Diesel common rail piezo injector |
| 5WS40000-Z  | 1980F0          | CITROËN      | Diesel common rail piezo injector |
| 5WS40000-Z  | 9652173780      | CITROËN      | Diesel common rail piezo injector |
| 5WS40000-Z  | 00001980F0      | PEUGEOT      | Diesel common rail piezo injector |
| 5WS40000-Z  | 1980F0          | PEUGEOT      | Diesel common rail piezo injector |
| 5WS40000-Z  | 9652173780      | PEUGEOT      | Diesel common rail piezo injector |
| 5WS40000-Z  | 5WS40000        | CONTINENTAL  | Diesel common rail piezo injector |
| 5WS40008-Z  | 00001920EP      | CITROËN      | Diesel common rail pump           |
| 5WS40008-Z  | 1920EP          | CITROËN      | Diesel common rail pump           |
| 5WS40008-Z  | 2S6Q9A543A      | FORD         | Diesel common rail pump           |
| 5WS40008-Z  | Y401-13-800B    | MAZDA        | Diesel common rail pump           |
| 5WS40008-Z  | 00001920EP      | PEUGEOT      | Diesel common rail pump           |
| 5WS40008-Z  | 1920EP          | PEUGEOT      | Diesel common rail pump           |
| 5WS40008-Z  | 9651590880      | PEUGEOT      | Diesel common rail pump           |
| 5WS40008-Z  | 5WS40008        | CONTINENTAL  | Diesel common rail pump           |
| 5WS40008-Z  | A2C20000727     | CONTINENTAL  | Diesel common rail pump           |
| 5WS40148-Z  | 00001980E7      | CITROËN      | Diesel common rail piezo injector |
| 5WS40148-Z  | 9655304780      | CITROËN      | Diesel common rail piezo injector |
| 5WS40148-Z  | 9655304880      | CITROËN      | Diesel common rail piezo injector |
| 5WS40148-Z  | 2S6Q9F593AA     | FORD         | Diesel common rail piezo injector |
| 5WS40148-Z  | 2S6Q9F593AB     | FORD         | Diesel common rail piezo injector |
| 5WS40148-Z  | 2S6Q9F593AC     | FORD         | Diesel common rail piezo injector |
| 5WS40148-Z  | 2S6Q9F593BB     | FORD         | Diesel common rail piezo injector |
| 5WS40148-Z  | 00001980E7      | PEUGEOT      | Diesel common rail piezo injector |
| 5WS40148-Z  | 1980E7          | PEUGEOT      | Diesel common rail piezo injector |
| 5WS40148-Z  | 9655304780      | PEUGEOT      | Diesel common rail piezo injector |
| 5WS40148-Z  | 9655304880      | PEUGEOT      | Diesel common rail piezo injector |
| 5WS40148-Z  | 5WS40007        | CONTINENTAL  | Diesel common rail piezo injector |
| 5WS40148-Z  | 5WS40148        | CONTINENTAL  | Diesel common rail piezo injector |
| 5WS40156-4Z | 00001980J4      | CITROËN      | Diesel common rail piezo injector |
| 5WS40156-4Z | 1980J4          | CITROËN      | Diesel common rail piezo injector |

| Article-No. | OE-No./Ref.-No. | Manufacturer | Product name                      |
|-------------|-----------------|--------------|-----------------------------------|
| 5WS40156-4Z | 9657144680      | FIAT         | Diesel common rail piezo injector |
| 5WS40156-4Z | 1373549         | FORD         | Diesel common rail piezo injector |
| 5WS40156-4Z | 3M5Q9F593DB     | FORD         | Diesel common rail piezo injector |
| 5WS40156-4Z | 00001980J4      | PEUGEOT      | Diesel common rail piezo injector |
| 5WS40156-4Z | 1980J4          | PEUGEOT      | Diesel common rail piezo injector |
| 5WS40156-4Z | 36000315        | VOLVO        | Diesel common rail piezo injector |
| 5WS40156-4Z | 36000317        | VOLVO        | Diesel common rail piezo injector |
| 5WS40156-4Z | 5WS40156-4      | CONTINENTAL  | Diesel common rail piezo injector |
| 5WS40156-Z  | 00001980J5      | CITROËN      | Diesel common rail piezo injector |
| 5WS40156-Z  | 1980J5          | CITROËN      | Diesel common rail piezo injector |
| 5WS40156-Z  | 1373550         | FORD         | Diesel common rail piezo injector |
| 5WS40156-Z  | 3M5Q9F593EB     | FORD         | Diesel common rail piezo injector |
| 5WS40156-Z  | 00001980J5      | PEUGEOT      | Diesel common rail piezo injector |
| 5WS40156-Z  | 1980J5          | PEUGEOT      | Diesel common rail piezo injector |
| 5WS40156-Z  | 36000318        | VOLVO        | Diesel common rail piezo injector |
| 5WS40156-Z  | 36000319        | VOLVO        | Diesel common rail piezo injector |
| 5WS40156-Z  | 5WS40156        | CONTINENTAL  | Diesel common rail piezo injector |
| 5WS40809-Z  | 00001920QH      | CITROËN      | Diesel common rail pump           |
| 5WS40809-Z  | 1920QH          | CITROËN      | Diesel common rail pump           |
| 5WS40809-Z  | 9688153080      | CITROËN      | Diesel common rail pump           |
| 5WS40809-Z  | 9681945580      | FIAT         | Diesel common rail pump           |
| 5WS40809-Z  | 9684704880      | FIAT         | Diesel common rail pump           |
| 5WS40809-Z  | 1373546         | FORD         | Diesel common rail pump           |
| 5WS40809-Z  | 3M5Q9A543BD     | FORD         | Diesel common rail pump           |
| 5WS40809-Z  | 00001920QH      | PEUGEOT      | Diesel common rail pump           |
| 5WS40809-Z  | 1920QH          | PEUGEOT      | Diesel common rail pump           |
| 5WS40809-Z  | 9688153080      | PEUGEOT      | Diesel common rail pump           |
| 5WS40809-Z  | 5WS40809        | CONTINENTAL  | Diesel common rail pump           |
| 5WS40809-Z  | A2C20000598     | CONTINENTAL  | Diesel common rail pump           |
| A2C59507596 | 166006212R      | RENAULT      | Diesel common rail piezo injector |
| A2C59507596 | 166006526R      | RENAULT      | Diesel common rail piezo injector |





| Article-No. | OE-No./Ref.-No. | Manufacturer | Product name  |
|-------------|-----------------|--------------|---|
| A2C59507596 | 8201041272      | RENAULT      |  Diesel common rail piezo injector   |
| A2C59507596 | 166006212R      | DACIA        |  Diesel common rail piezo injector   |
| A2C59507596 | 166006526R      | DACIA        |  Diesel common rail piezo injector   |
| A2C59507596 | 8201041272      | DACIA        |  Diesel common rail piezo injector   |
| A2C59507596 | A2C53381618     | CONTINENTAL  |  Diesel common rail piezo injector   |
| A2C59507608 | 16 70 036 69R   | RENAULT      |  Diesel common rail pump             |
| A2C59507608 | 16 70 085 57R   | RENAULT      |  Diesel common rail pump             |
| A2C59507608 | 16 70 089 97R   | RENAULT      |  Diesel common rail pump             |
| A2C59507608 | 16 70 036 69R   | DACIA        |  Diesel common rail pump             |
| A2C59507608 | 16 70 085 57R   | DACIA        |  Diesel common rail pump             |
| A2C59507608 | 16 70 089 97R   | DACIA        |  Diesel common rail pump             |
| A2C59507608 | A2C53351931     | CONTINENTAL  |  Diesel common rail pump             |
| A2C59511314 | 00001920HJ      | CITROËN      |  Diesel common rail pump            |
| A2C59511314 | 1920HJ          | CITROËN      |  Diesel common rail pump           |
| A2C59511314 | 02C2S40185      | JAGUAR       |  Diesel common rail pump           |
| A2C59511314 | 00001920HJ      | PEUGEOT      |  Diesel common rail pump           |
| A2C59511314 | 1920HJ          | PEUGEOT      |  Diesel common rail pump           |
| A2C59511314 | LR005958        | LAND ROVER   |  Diesel common rail pump           |
| A2C59511314 | LR009804        | LAND ROVER   |  Diesel common rail pump           |
| A2C59511314 | LR024834        | LAND ROVER   |  Diesel common rail pump           |
| A2C59511314 | 5WS40157        | CONTINENTAL  |  Diesel common rail pump           |
| A2C59511314 | A2C20003757     | CONTINENTAL  |  Diesel common rail pump           |
| A2C59511315 | 02XR856939      | JAGUAR       |  Diesel common rail piezo injector |
| A2C59511316 | 00001980H1      | CITROËN      |  Diesel common rail piezo injector |
| A2C59511316 | 02C2S40004      | JAGUAR       |  Diesel common rail piezo injector |
| A2C59511316 | 1980H1          | PEUGEOT      |  Diesel common rail piezo injector |
| A2C59511364 | 4H2Q9K546AF     | FORD         |  Diesel common rail piezo injector |
| A2C59511364 | LR006495        | LAND ROVER   |  Diesel common rail piezo injector |
| A2C59511364 | LR008836        | LAND ROVER   |  Diesel common rail piezo injector |
| A2C59511600 | 1541974         | FORD         |  Diesel common rail pump           |
| A2C59511600 | 3M5Q9A543CD     | FORD         |  Diesel common rail pump           |































| Article-No. | OE-No./Ref.-No. | Manufacturer | Product name  |
|-------------|-----------------|--------------|---|
| A2C59511600 | 36002487        | VOLVO        |  Diesel common rail pump             |
| A2C59511600 | 5WS40380        | CONTINENTAL  |  Diesel common rail pump             |
| A2C59511600 | A2C27100268     | CONTINENTAL  |  Diesel common rail pump             |
| A2C59511601 | 00001980J6      | CITROËN      |  Diesel common rail piezo injector   |
| A2C59511601 | 1980J6          | CITROËN      |  Diesel common rail piezo injector   |
| A2C59511601 | 9657144880      | FIAT         |  Diesel common rail piezo injector   |
| A2C59511601 | 1483820         | FORD         |  Diesel common rail piezo injector   |
| A2C59511601 | 3M5Q9F593FB     | FORD         |  Diesel common rail piezo injector   |
| A2C59511601 | 00001980J6      | PEUGEOT      |  Diesel common rail piezo injector   |
| A2C59511601 | 1980J6          | PEUGEOT      |  Diesel common rail piezo injector   |
| A2C59511602 | 00001980K5      | CITROËN      |  Diesel common rail piezo injector   |
| A2C59511602 | 1980K5          | CITROËN      |  Diesel common rail piezo injector   |
| A2C59511602 | 9659337980      | FIAT         |  Diesel common rail piezo injector  |
| A2C59511602 | 00001980K5      | PEUGEOT      |  Diesel common rail piezo injector |
| A2C59511602 | 1980K5          | PEUGEOT      |  Diesel common rail piezo injector |
| A2C59511605 | 16700 00Q0N     | NISSAN       |  Diesel common rail pump           |
| A2C59511605 | 16700 00Q1C     | NISSAN       |  Diesel common rail pump           |
| A2C59511605 | 16700 00Q1L     | NISSAN       |  Diesel common rail pump           |
| A2C59511605 | 167008859R      | RENAULT      |  Diesel common rail pump           |
| A2C59511605 | 8200430599      | RENAULT      |  Diesel common rail pump           |
| A2C59511605 | 8200663258      | RENAULT      |  Diesel common rail pump           |
| A2C59511605 | 8200821184      | RENAULT      |  Diesel common rail pump           |
| A2C59511605 | 5WS40153        | CONTINENTAL  |  Diesel common rail pump           |
| A2C59511605 | A2C20000754     | CONTINENTAL  |  Diesel common rail pump           |
| A2C59511606 | 16600 00Q0H     | NISSAN       |  Diesel common rail piezo injector |
| A2C59511606 | 16600 00Q0P     | NISSAN       |  Diesel common rail piezo injector |
| A2C59511606 | 16600 00Q1T     | NISSAN       |  Diesel common rail piezo injector |
| A2C59511606 | 166009445R      | RENAULT      |  Diesel common rail piezo injector |
| A2C59511606 | 8200380253      | RENAULT      |  Diesel common rail piezo injector |
| A2C59511606 | 8200842205      | RENAULT      |  Diesel common rail piezo injector |
| A2C59511609 | 1543842         | FORD         |  Diesel common rail pump           |

































| Article-No. | OE-No./Ref.-No. | Manufacturer | Product name                      |
|-------------|-----------------|--------------|-----------------------------------|
| A2C59511609 | 4M5Q9B395AF     | FORD         | Diesel common rail pump           |
| A2C59511609 | 5WS40094        | CONTINENTAL  | Diesel common rail pump           |
| A2C59511609 | A2C20003032     | CONTINENTAL  | Diesel common rail pump           |
| A2C59511610 | 1355051         | FORD         | Diesel common rail piezo injector |
| A2C59511610 | 4M5Q9F593AD     | FORD         | Diesel common rail piezo injector |
| A2C59511611 | 1432322         | FORD         | Diesel common rail piezo injector |
| A2C59511611 | 7T1Q9F593AB     | FORD         | Diesel common rail piezo injector |
| A2C59511612 | 00001980L0      | CITROËN      | Diesel common rail piezo injector |
| A2C59511612 | 1980L0          | CITROËN      | Diesel common rail piezo injector |
| A2C59511612 | Y404-13-250A    | MAZDA        | Diesel common rail piezo injector |
| A2C59511612 | 00001980L0      | PEUGEOT      | Diesel common rail piezo injector |
| A2C59511612 | 1980L0          | PEUGEOT      | Diesel common rail piezo injector |
| A2C59511612 | 9663429280      | PEUGEOT      | Diesel common rail piezo injector |
| A2C59511612 | 5WS40149-Z      | VDO          | Diesel common rail piezo injector |
| A2C59511612 | 5WS40516        | CONTINENTAL  | Diesel common rail piezo injector |
| A2C59513481 | 6H4Q9B395BG     | FORD         | Diesel common rail pump           |
| A2C59513481 | LR006735        | LAND ROVER   | Diesel common rail pump           |
| A2C59513481 | LR009737        | LAND ROVER   | Diesel common rail pump           |
| A2C59513481 | LR010136        | LAND ROVER   | Diesel common rail pump           |
| A2C59513481 | LR010189        | LAND ROVER   | Diesel common rail pump           |
| A2C59513481 | 5WS40254        | CONTINENTAL  | Diesel common rail pump           |
| A2C59513481 | A2C20003180     | CONTINENTAL  | Diesel common rail pump           |
| A2C59513482 | 7H2Q9B395CH     | LAND ROVER   | Diesel common rail pump           |
| A2C59513482 | LR005549        | LAND ROVER   | Diesel common rail pump           |
| A2C59513482 | LR008831        | LAND ROVER   | Diesel common rail pump           |
| A2C59513482 | LR009666        | LAND ROVER   | Diesel common rail pump           |
| A2C59513482 | LR017367        | LAND ROVER   | Diesel common rail pump           |
| A2C59513482 | LR049606        | LAND ROVER   | Diesel common rail pump           |
| A2C59513482 | 5WS40273        | CONTINENTAL  | Diesel common rail pump           |
| A2C59513482 | A2C20003282     | CONTINENTAL  | Diesel common rail pump           |
| A2C59513484 | 16600 00Q1F     | NISSAN       | Diesel common rail piezo injector |

















| Article-No. | OE-No./Ref.-No. | Manufacturer | Product name                      |
|-------------|-----------------|--------------|-----------------------------------|
| A2C59513484 | 16 60 043 05R   | RENAULT      | Diesel common rail piezo injector |
| A2C59513484 | 16 60 080 52R   | RENAULT      | Diesel common rail piezo injector |
| A2C59513484 | 8200903034      | RENAULT      | Diesel common rail piezo injector |
| A2C59513484 | 16 60 043 05R   | DACIA        | Diesel common rail piezo injector |
| A2C59513484 | 16 60 080 52R   | DACIA        | Diesel common rail piezo injector |
| A2C59513484 | 8200903034      | DACIA        | Diesel common rail piezo injector |
| A2C59513552 | 00001980K8      | CITROËN      | Diesel common rail piezo injector |
| A2C59513552 | 1980K8          | CITROËN      | Diesel common rail piezo injector |
| A2C59513552 | 00001980K8      | PEUGEOT      | Diesel common rail piezo injector |
| A2C59513552 | 1980K8          | PEUGEOT      | Diesel common rail piezo injector |
| A2C59513553 | 7H2Q9K546CB     | FORD         | Diesel common rail piezo injector |
| A2C59513553 | LR006496        | LAND ROVER   | Diesel common rail piezo injector |
| A2C59513553 | LR008837        | LAND ROVER   | Diesel common rail piezo injector |
| A2C59513554 | 03L 130 277 B   | AUDI         | Diesel common rail piezo injector |
| A2C59513554 | 03L 130 277 B   | SEAT         | Diesel common rail piezo injector |
| A2C59513554 | 03L 130 277 B   | SKODA        | Diesel common rail piezo injector |
| A2C59513554 | 03L 130 277 B   | VW           | Diesel common rail piezo injector |
| A2C59513556 | 00001980ER      | CITROËN      | Diesel common rail piezo injector |
| A2C59513556 | 00001980ET      | CITROËN      | Diesel common rail piezo injector |
| A2C59513556 | 00001980R9      | CITROËN      | Diesel common rail piezo injector |
| A2C59513556 | 00001980S0      | CITROËN      | Diesel common rail piezo injector |
| A2C59513556 | 1980ER          | CITROËN      | Diesel common rail piezo injector |
| A2C59513556 | 1980ET          | CITROËN      | Diesel common rail piezo injector |
| A2C59513556 | 1980R9          | CITROËN      | Diesel common rail piezo injector |
| A2C59513556 | 1980S0          | CITROËN      | Diesel common rail piezo injector |
| A2C59513556 | 9802448680      | CITROËN      | Diesel common rail piezo injector |
| A2C59513556 | 1791017         | FORD         | Diesel common rail piezo injector |
| A2C59513556 | 1812616         | FORD         | Diesel common rail piezo injector |
| A2C59513556 | 00001980ER      | PEUGEOT      | Diesel common rail piezo injector |
| A2C59513556 | 00001980ET      | PEUGEOT      | Diesel common rail piezo injector |
| A2C59513556 | 00001980R9      | PEUGEOT      | Diesel common rail piezo injector |



| Article-No. | OE-No./Ref.-No. | Manufacturer | Product name  |
|-------------|-----------------|--------------|---|
| A2C59513556 | 00001980S0      | PEUGEOT      |  Diesel common rail piezo injector   |
| A2C59513556 | 1980ER          | PEUGEOT      |  Diesel common rail piezo injector   |
| A2C59513556 | 1980ET          | PEUGEOT      |  Diesel common rail piezo injector   |
| A2C59513556 | 1980R9          | PEUGEOT      |  Diesel common rail piezo injector   |
| A2C59513556 | 1980S0          | PEUGEOT      |  Diesel common rail piezo injector   |
| A2C59513556 | 9802448680      | PEUGEOT      |  Diesel common rail piezo injector   |
| A2C59513556 | 36001726        | VOLVO        |  Diesel common rail piezo injector   |
| A2C59513556 | 36001727        | VOLVO        |  Diesel common rail piezo injector   |
| A2C59513556 | 36001728        | VOLVO        |  Diesel common rail piezo injector   |
| A2C59513556 | 36001729        | VOLVO        |  Diesel common rail piezo injector   |
| A2C59513595 | 16700 00Q1F     | NISSAN       |  Diesel common rail pump             |
| A2C59513595 | 16700 00Q1M     | NISSAN       |  Diesel common rail pump             |
| A2C59513595 | 16 70 000 61R   | RENAULT      |  Diesel common rail pump            |
| A2C59513595 | 16 70 009 38R   | RENAULT      |  Diesel common rail pump           |
| A2C59513595 | 8200704200      | RENAULT      |  Diesel common rail pump           |
| A2C59513595 | 16 70 000 61R   | DACIA        |  Diesel common rail pump           |
| A2C59513595 | 16 70 009 38R   | DACIA        |  Diesel common rail pump           |
| A2C59513595 | 8200704200      | DACIA        |  Diesel common rail pump           |
| A2C59513595 | 5WS40565        | CONTINENTAL  |  Diesel common rail pump           |
| A2C59513595 | A2C53252602     | CONTINENTAL  |  Diesel common rail pump           |
| A2C59513596 | 6H4Q9K546DB     | LAND ROVER   |  Diesel common rail piezo injector |
| A2C59513596 | LR0008832       | LAND ROVER   |  Diesel common rail piezo injector |
| A2C59513596 | LR0008834       | LAND ROVER   |  Diesel common rail piezo injector |
| A2C59513596 | LR002473        | LAND ROVER   |  Diesel common rail piezo injector |
| A2C59513596 | LR002475        | LAND ROVER   |  Diesel common rail piezo injector |
| A2C59513597 | 6H4Q9K546EB     | LAND ROVER   |  Diesel common rail piezo injector |
| A2C59513597 | LR0008833       | LAND ROVER   |  Diesel common rail piezo injector |
| A2C59513597 | LR0008835       | LAND ROVER   |  Diesel common rail piezo injector |
| A2C59513597 | LR002474        | LAND ROVER   |  Diesel common rail piezo injector |
| A2C59513597 | LR002476        | LAND ROVER   |  Diesel common rail piezo injector |
| A2C59513829 | 1720038         | FORD         |  Diesel common rail pump           |































| Article-No. | OE-No./Ref.-No. | Manufacturer | Product name  |
|-------------|-----------------|--------------|---|
| A2C59513829 | 1804823         | FORD         |  Diesel common rail pump   |
| A2C59513829 | 36001730        | VOLVO        |  Diesel common rail pump   |
| A2C59513829 | 5WS40893        | CONTINENTAL  |  Diesel common rail pump   |
| A2C59513829 | A2C53384062     | CONTINENTAL  |  Diesel common rail pump   |
| A2C59513830 | 00001920QX      | CITROËN      |  Diesel common rail pump   |
| A2C59513830 | 00001920RY      | CITROËN      |  Diesel common rail pump   |
| A2C59513830 | 1920QX          | CITROËN      |  Diesel common rail pump   |
| A2C59513830 | 1920RY          | CITROËN      |  Diesel common rail pump   |
| A2C59513830 | 00001920QX      | PEUGEOT      |  Diesel common rail pump   |
| A2C59513830 | 00001920RY      | PEUGEOT      |  Diesel common rail pump   |
| A2C59513830 | 1920QX          | PEUGEOT      |  Diesel common rail pump   |
| A2C59513830 | 1920RY          | PEUGEOT      |  Diesel common rail pump   |
| A2C59513830 | 5WS40894        | CONTINENTAL  |  Diesel common rail pump  |
| A2C59513830 | A2C53381555     | CONTINENTAL  |  Diesel common rail pump |
| A2C59517043 | 1717702         | FORD         |  Diesel common rail pump |
| A2C59517043 | 1841728         | FORD         |  Diesel common rail pump |
| A2C59517043 | 1849878         | FORD         |  Diesel common rail pump |
| A2C59517043 | LR029969        | LAND ROVER   |  Diesel common rail pump |
| A2C59517043 | LR052872        | LAND ROVER   |  Diesel common rail pump |
| A2C59517043 | 5WS40695        | CONTINENTAL  |  Diesel common rail pump |
| A2C59517043 | A2C53344441     | CONTINENTAL  |  Diesel common rail pump |
| A2C59517045 | 9678171880      | CITROËN      |  Diesel common rail pump |
| A2C59517045 | 1731745         | FORD         |  Diesel common rail pump |
| A2C59517045 | 1841726         | FORD         |  Diesel common rail pump |
| A2C59517045 | 9678171880      | PEUGEOT      |  Diesel common rail pump |
| A2C59517045 | 5WS40694        | CONTINENTAL  |  Diesel common rail pump |
| A2C59517045 | A2C53344443     | CONTINENTAL  |  Diesel common rail pump |
| A2C59517047 | 03L 130 755 AL  | AUDI         |  Diesel common rail pump |
| A2C59517047 | 03L 130 755 E   | AUDI         |  Diesel common rail pump |
| A2C59517047 | 03L 130 755 AL  | SEAT         |  Diesel common rail pump |
| A2C59517047 | 03L 130 755 E   | SEAT         |  Diesel common rail pump |



| Article-No. | OE-No./Ref.-No. | Manufacturer | Product name  |
|-------------|-----------------|--------------|---|
| A2C59517047 | 03L 130 755 AL  | SKODA        |  Diesel common rail pump             |
| A2C59517047 | 03L 130 755 E   | SKODA        |  Diesel common rail pump             |
| A2C59517047 | 03L 130 755 AL  | VW           |  Diesel common rail pump             |
| A2C59517047 | 03L 130 755 E   | VW           |  Diesel common rail pump             |
| A2C59517047 | 5WS40836        | CONTINENTAL  |  Diesel common rail pump             |
| A2C59517047 | A2C53341464     | CONTINENTAL  |  Diesel common rail pump             |
| A2C59517049 | 03L 130 755 AN  | AUDI         |  Diesel common rail pump             |
| A2C59517049 | 03L 130 755 AN  | SEAT         |  Diesel common rail pump             |
| A2C59517049 | 03L 130 755 AN  | SKODA        |  Diesel common rail pump             |
| A2C59517049 | 03L 130 755 AN  | VW           |  Diesel common rail pump             |
| A2C59517049 | 5WS40891        | CONTINENTAL  |  Diesel common rail pump             |
| A2C59517049 | A2C53366731     | CONTINENTAL  |  Diesel common rail pump            |
| A2C59517051 | 9801125480      | CITROËN      |  Diesel common rail piezo injector |
| A2C59517051 | 1746967         | FORD         |  Diesel common rail piezo injector |
| A2C59517051 | 1840747         | FORD         |  Diesel common rail piezo injector |
| A2C59517051 | 9801125480      | PEUGEOT      |  Diesel common rail piezo injector |
| A2C59517051 | LR032067        | LAND ROVER   |  Diesel common rail piezo injector |

| Article-No. | OE-No./Ref.-No. | Manufacturer | Product name |
|-------------|-----------------|--------------|--------------|
|-------------|-----------------|--------------|--------------|

































































| OE-No./Ref.-No. | Manufacturer | Article-No. | Product name  |
|-----------------|--------------|-------------|---|
| 00001920EP      | CITROËN      | 5WS40008-Z  |  Diesel common rail pump             |
| 00001920EP      | PEUGEOT      | 5WS40008-Z  |  Diesel common rail pump             |
| 00001920HJ      | CITROËN      | A2C59511314 |  Diesel common rail pump             |
| 00001920HJ      | PEUGEOT      | A2C59511314 |  Diesel common rail pump             |
| 00001920QH      | CITROËN      | 5WS40809-Z  |  Diesel common rail pump             |
| 00001920QH      | PEUGEOT      | 5WS40809-Z  |  Diesel common rail pump             |
| 00001920QX      | CITROËN      | A2C59513830 |  Diesel common rail pump             |
| 00001920QX      | PEUGEOT      | A2C59513830 |  Diesel common rail pump             |
| 00001920RY      | CITROËN      | A2C59513830 |  Diesel common rail pump             |
| 00001920RY      | PEUGEOT      | A2C59513830 |  Diesel common rail pump             |
| 00001980E7      | CITROËN      | 5WS40148-Z  |  Diesel common rail piezo injector   |
| 00001980E7      | PEUGEOT      | 5WS40148-Z  |  Diesel common rail piezo injector   |
| 00001980ER      | CITROËN      | A2C59513556 |  Diesel common rail piezo injector   |
| 00001980ER      | PEUGEOT      | A2C59513556 |  Diesel common rail piezo injector |
| 00001980ET      | CITROËN      | A2C59513556 |  Diesel common rail piezo injector |
| 00001980ET      | PEUGEOT      | A2C59513556 |  Diesel common rail piezo injector |
| 00001980F0      | CITROËN      | 5WS40000-Z  |  Diesel common rail piezo injector |
| 00001980F0      | PEUGEOT      | 5WS40000-Z  |  Diesel common rail piezo injector |
| 00001980H1      | CITROËN      | A2C59511316 |  Diesel common rail piezo injector |
| 00001980J4      | CITROËN      | 5WS40156-4Z |  Diesel common rail piezo injector |
| 00001980J4      | PEUGEOT      | 5WS40156-4Z |  Diesel common rail piezo injector |
| 00001980J5      | CITROËN      | 5WS40156-Z  |  Diesel common rail piezo injector |
| 00001980J5      | PEUGEOT      | 5WS40156-Z  |  Diesel common rail piezo injector |
| 00001980J6      | CITROËN      | A2C59511601 |  Diesel common rail piezo injector |
| 00001980J6      | PEUGEOT      | A2C59511601 |  Diesel common rail piezo injector |
| 00001980K5      | CITROËN      | A2C59511602 |  Diesel common rail piezo injector |
| 00001980K5      | PEUGEOT      | A2C59511602 |  Diesel common rail piezo injector |
| 00001980K8      | CITROËN      | A2C59513552 |  Diesel common rail piezo injector |
| 00001980K8      | PEUGEOT      | A2C59513552 |  Diesel common rail piezo injector |
| 00001980L0      | CITROËN      | A2C59511612 |  Diesel common rail piezo injector |
| 00001980L0      | PEUGEOT      | A2C59511612 |  Diesel common rail piezo injector |

| OE-No./Ref.-No. | Manufacturer | Article-No. | Product name  |
|-----------------|--------------|-------------|---|
| 00001980R9      | CITROËN      | A2C59513556 |  Diesel common rail piezo injector   |
| 00001980R9      | PEUGEOT      | A2C59513556 |  Diesel common rail piezo injector   |
| 00001980S0      | CITROËN      | A2C59513556 |  Diesel common rail piezo injector   |
| 00001980S0      | PEUGEOT      | A2C59513556 |  Diesel common rail piezo injector   |
| 02C2S40004      | JAGUAR       | A2C59511316 |  Diesel common rail piezo injector   |
| 02C2S40185      | JAGUAR       | A2C59511314 |  Diesel common rail pump             |
| 02XR856939      | JAGUAR       | A2C59511315 |  Diesel common rail piezo injector   |
| 03L 130 277 B   | AUDI         | A2C59513554 |  Diesel common rail piezo injector   |
| 03L 130 277 B   | SEAT         | A2C59513554 |  Diesel common rail piezo injector   |
| 03L 130 277 B   | SKODA        | A2C59513554 |  Diesel common rail piezo injector   |
| 03L 130 277 B   | VW           | A2C59513554 |  Diesel common rail piezo injector   |
| 03L 130 755 AL  | AUDI         | A2C59517047 |  Diesel common rail pump             |
| 03L 130 755 AL  | SEAT         | A2C59517047 |  Diesel common rail pump             |
| 03L 130 755 AL  | SKODA        | A2C59517047 |  Diesel common rail pump           |
| 03L 130 755 AL  | VW           | A2C59517047 |  Diesel common rail pump           |
| 03L 130 755 AN  | AUDI         | A2C59517049 |  Diesel common rail pump           |
| 03L 130 755 AN  | SEAT         | A2C59517049 |  Diesel common rail pump           |
| 03L 130 755 AN  | SKODA        | A2C59517049 |  Diesel common rail pump           |
| 03L 130 755 AN  | VW           | A2C59517049 |  Diesel common rail pump           |
| 03L 130 755 E   | AUDI         | A2C59517047 |  Diesel common rail pump           |
| 03L 130 755 E   | SEAT         | A2C59517047 |  Diesel common rail pump           |
| 03L 130 755 E   | SKODA        | A2C59517047 |  Diesel common rail pump           |
| 03L 130 755 E   | VW           | A2C59517047 |  Diesel common rail pump           |
| 1355051         | FORD         | A2C59511610 |  Diesel common rail piezo injector |
| 1373546         | FORD         | 5WS40809-Z  |  Diesel common rail pump           |
| 1373549         | FORD         | 5WS40156-4Z |  Diesel common rail piezo injector |
| 1373550         | FORD         | 5WS40156-Z  |  Diesel common rail piezo injector |
| 1432322         | FORD         | A2C59511611 |  Diesel common rail piezo injector |
| 1483820         | FORD         | A2C59511601 |  Diesel common rail piezo injector |
| 1541974         | FORD         | A2C59511600 |  Diesel common rail pump           |
| 1543842         | FORD         | A2C59511609 |  Diesel common rail pump           |

























































# Cross Reference List OE No. → Art.-No.

| OE-No./Ref.-No. | Manufacturer | Article-No. | Product name  |
|-----------------|--------------|-------------|---|
| 16600 00Q0H     | NISSAN       | A2C59511606 |  Diesel common rail piezo injector |
| 16600 00Q0P     | NISSAN       | A2C59511606 |  Diesel common rail piezo injector |
| 16600 00Q1F     | NISSAN       | A2C59513484 |  Diesel common rail piezo injector |
| 16600 00Q1T     | NISSAN       | A2C59511606 |  Diesel common rail piezo injector |
| 16 60 043 05R   | RENAULT      | A2C59513484 |  Diesel common rail piezo injector |
| 16 60 043 05R   | DACIA        | A2C59513484 |  Diesel common rail piezo injector |
| 166006212R      | RENAULT      | A2C59507596 |  Diesel common rail piezo injector |
| 166006212R      | DACIA        | A2C59507596 |  Diesel common rail piezo injector |
| 166006526R      | RENAULT      | A2C59507596 |  Diesel common rail piezo injector |
| 166006526R      | DACIA        | A2C59507596 |  Diesel common rail piezo injector |
| 16 60 080 52R   | RENAULT      | A2C59513484 |  Diesel common rail piezo injector |
| 16 60 080 52R   | DACIA        | A2C59513484 |  Diesel common rail piezo injector |
| 166009445R      | RENAULT      | A2C59511606 |  Diesel common rail piezo injector |
| 16 70 000 61R   | RENAULT      | A2C59513595 |  Diesel common rail pump         |
| 16 70 000 61R   | DACIA        | A2C59513595 |  Diesel common rail pump         |
| 16700 00Q0N     | NISSAN       | A2C59511605 |  Diesel common rail pump         |
| 16700 00Q1C     | NISSAN       | A2C59511605 |  Diesel common rail pump         |
| 16700 00Q1F     | NISSAN       | A2C59513595 |  Diesel common rail pump         |
| 16700 00Q1L     | NISSAN       | A2C59511605 |  Diesel common rail pump         |
| 16700 00Q1M     | NISSAN       | A2C59513595 |  Diesel common rail pump         |
| 16 70 009 38R   | RENAULT      | A2C59513595 |  Diesel common rail pump         |
| 16 70 009 38R   | DACIA        | A2C59513595 |  Diesel common rail pump         |
| 16 70 036 69R   | RENAULT      | A2C59507608 |  Diesel common rail pump         |
| 16 70 036 69R   | DACIA        | A2C59507608 |  Diesel common rail pump         |
| 16 70 085 57R   | RENAULT      | A2C59507608 |  Diesel common rail pump         |
| 16 70 085 57R   | DACIA        | A2C59507608 |  Diesel common rail pump         |
| 167008859R      | RENAULT      | A2C59511605 |  Diesel common rail pump         |
| 16 70 089 97R   | RENAULT      | A2C59507608 |  Diesel common rail pump         |
| 16 70 089 97R   | DACIA        | A2C59507608 |  Diesel common rail pump         |
| 1717702         | FORD         | A2C59517043 |  Diesel common rail pump         |
| 1720038         | FORD         | A2C59513829 |  Diesel common rail pump         |

| OE-No./Ref.-No. | Manufacturer | Article-No. | Product name  |
|-----------------|--------------|-------------|---|
| 1731745         | FORD         | A2C59517045 |  Diesel common rail pump             |
| 1746967         | FORD         | A2C59517051 |  Diesel common rail piezo injector   |
| 1791017         | FORD         | A2C59513556 |  Diesel common rail piezo injector   |
| 1804823         | FORD         | A2C59513829 |  Diesel common rail pump             |
| 1812616         | FORD         | A2C59513556 |  Diesel common rail piezo injector   |
| 1840747         | FORD         | A2C59517051 |  Diesel common rail piezo injector   |
| 1841726         | FORD         | A2C59517045 |  Diesel common rail pump             |
| 1841728         | FORD         | A2C59517043 |  Diesel common rail pump             |
| 1849878         | FORD         | A2C59517043 |  Diesel common rail pump             |
| 1920EP          | CITROËN      | 5WS40008-Z  |  Diesel common rail pump             |
| 1920EP          | PEUGEOT      | 5WS40008-Z  |  Diesel common rail pump             |
| 1920HJ          | CITROËN      | A2C59511314 |  Diesel common rail pump             |
| 1920HJ          | PEUGEOT      | A2C59511314 |  Diesel common rail pump             |
| 1920QH          | CITROËN      | 5WS40809-Z  |  Diesel common rail pump           |
| 1920QH          | PEUGEOT      | 5WS40809-Z  |  Diesel common rail pump           |
| 1920QX          | CITROËN      | A2C59513830 |  Diesel common rail pump           |
| 1920QX          | PEUGEOT      | A2C59513830 |  Diesel common rail pump           |
| 1920RY          | CITROËN      | A2C59513830 |  Diesel common rail pump           |
| 1920RY          | PEUGEOT      | A2C59513830 |  Diesel common rail pump           |
| 1980E7          | PEUGEOT      | 5WS40148-Z  |  Diesel common rail piezo injector |
| 1980ER          | CITROËN      | A2C59513556 |  Diesel common rail piezo injector |
| 1980ER          | PEUGEOT      | A2C59513556 |  Diesel common rail piezo injector |
| 1980ET          | CITROËN      | A2C59513556 |  Diesel common rail piezo injector |
| 1980ET          | PEUGEOT      | A2C59513556 |  Diesel common rail piezo injector |
| 1980F0          | CITROËN      | 5WS40000-Z  |  Diesel common rail piezo injector |
| 1980F0          | PEUGEOT      | 5WS40000-Z  |  Diesel common rail piezo injector |
| 1980H1          | PEUGEOT      | A2C59511316 |  Diesel common rail piezo injector |
| 1980J4          | CITROËN      | 5WS40156-4Z |  Diesel common rail piezo injector |
| 1980J4          | PEUGEOT      | 5WS40156-4Z |  Diesel common rail piezo injector |
| 1980J5          | CITROËN      | 5WS40156-Z  |  Diesel common rail piezo injector |
| 1980J5          | PEUGEOT      | 5WS40156-Z  |  Diesel common rail piezo injector |

































































| OE-No./Ref.-No. | Manufacturer | Article-No. | Product name  |
|-----------------|--------------|-------------|---|
| 1980J6          | CITROËN      | A2C59511601 |  Diesel common rail piezo injector   |
| 1980J6          | PEUGEOT      | A2C59511601 |  Diesel common rail piezo injector   |
| 1980K5          | CITROËN      | A2C59511602 |  Diesel common rail piezo injector   |
| 1980K5          | PEUGEOT      | A2C59511602 |  Diesel common rail piezo injector   |
| 1980K8          | CITROËN      | A2C59513552 |  Diesel common rail piezo injector   |
| 1980K8          | PEUGEOT      | A2C59513552 |  Diesel common rail piezo injector   |
| 1980L0          | CITROËN      | A2C59511612 |  Diesel common rail piezo injector   |
| 1980L0          | PEUGEOT      | A2C59511612 |  Diesel common rail piezo injector   |
| 1980R9          | CITROËN      | A2C59513556 |  Diesel common rail piezo injector   |
| 1980R9          | PEUGEOT      | A2C59513556 |  Diesel common rail piezo injector   |
| 1980S0          | CITROËN      | A2C59513556 |  Diesel common rail piezo injector   |
| 1980S0          | PEUGEOT      | A2C59513556 |  Diesel common rail piezo injector   |
| 2S6Q9A543A      | FORD         | 5WS40008-Z  |  Diesel common rail pump            |
| 2S6Q9F593AA     | FORD         | 5WS40148-Z  |  Diesel common rail piezo injector |
| 2S6Q9F593AB     | FORD         | 5WS40148-Z  |  Diesel common rail piezo injector |
| 2S6Q9F593AC     | FORD         | 5WS40148-Z  |  Diesel common rail piezo injector |
| 2S6Q9F593BB     | FORD         | 5WS40148-Z  |  Diesel common rail piezo injector |
| 36000315        | VOLVO        | 5WS40156-4Z |  Diesel common rail piezo injector |
| 36000317        | VOLVO        | 5WS40156-4Z |  Diesel common rail piezo injector |
| 36000318        | VOLVO        | 5WS40156-Z  |  Diesel common rail piezo injector |
| 36000319        | VOLVO        | 5WS40156-Z  |  Diesel common rail piezo injector |
| 36001726        | VOLVO        | A2C59513556 |  Diesel common rail piezo injector |
| 36001727        | VOLVO        | A2C59513556 |  Diesel common rail piezo injector |
| 36001728        | VOLVO        | A2C59513556 |  Diesel common rail piezo injector |
| 36001729        | VOLVO        | A2C59513556 |  Diesel common rail piezo injector |
| 36001730        | VOLVO        | A2C59513829 |  Diesel common rail pump           |
| 36002487        | VOLVO        | A2C59511600 |  Diesel common rail pump           |
| 3M5Q9A543BD     | FORD         | 5WS40809-Z  |  Diesel common rail pump           |
| 3M5Q9A543CD     | FORD         | A2C59511600 |  Diesel common rail pump           |
| 3M5Q9F593DB     | FORD         | 5WS40156-4Z |  Diesel common rail piezo injector |
| 3M5Q9F593EB     | FORD         | 5WS40156-Z  |  Diesel common rail piezo injector |

| OE-No./Ref.-No. | Manufacturer | Article-No. | Product name  |
|-----------------|--------------|-------------|---|
| 3M5Q9F593FB     | FORD         | A2C59511601 |  Diesel common rail piezo injector   |
| 4H2Q9K546AF     | FORD         | A2C59511364 |  Diesel common rail piezo injector   |
| 4M5Q9B395AF     | FORD         | A2C59511609 |  Diesel common rail pump             |
| 4M5Q9F593AD     | FORD         | A2C59511610 |  Diesel common rail piezo injector   |
| 5WS40000        | CONTINENTAL  | 5WS40000-Z  |  Diesel common rail piezo injector   |
| 5WS40007        | CONTINENTAL  | 5WS40148-Z  |  Diesel common rail piezo injector   |
| 5WS40008        | CONTINENTAL  | 5WS40008-Z  |  Diesel common rail pump             |
| 5WS40094        | CONTINENTAL  | A2C59511609 |  Diesel common rail pump             |
| 5WS40148        | CONTINENTAL  | 5WS40148-Z  |  Diesel common rail piezo injector   |
| 5WS40149-Z      | VDO          | A2C59511612 |  Diesel common rail piezo injector   |
| 5WS40153        | CONTINENTAL  | A2C59511605 |  Diesel common rail pump             |
| 5WS40156        | CONTINENTAL  | 5WS40156-Z  |  Diesel common rail piezo injector   |
| 5WS40156-4      | CONTINENTAL  | 5WS40156-4Z |  Diesel common rail piezo injector  |
| 5WS40157        | CONTINENTAL  | A2C59511314 |  Diesel common rail pump           |
| 5WS40254        | CONTINENTAL  | A2C59513481 |  Diesel common rail pump           |
| 5WS40273        | CONTINENTAL  | A2C59513482 |  Diesel common rail pump           |
| 5WS40380        | CONTINENTAL  | A2C59511600 |  Diesel common rail pump           |
| 5WS40516        | CONTINENTAL  | A2C59511612 |  Diesel common rail piezo injector |
| 5WS40565        | CONTINENTAL  | A2C59513595 |  Diesel common rail pump           |
| 5WS40694        | CONTINENTAL  | A2C59517045 |  Diesel common rail pump           |
| 5WS40695        | CONTINENTAL  | A2C59517043 |  Diesel common rail pump           |
| 5WS40809        | CONTINENTAL  | 5WS40809-Z  |  Diesel common rail pump           |
| 5WS40836        | CONTINENTAL  | A2C59517047 |  Diesel common rail pump           |
| 5WS40891        | CONTINENTAL  | A2C59517049 |  Diesel common rail pump           |
| 5WS40893        | CONTINENTAL  | A2C59513829 |  Diesel common rail pump           |
| 5WS40894        | CONTINENTAL  | A2C59513830 |  Diesel common rail pump           |
| 6H4Q9B395BG     | FORD         | A2C59513481 |  Diesel common rail pump           |
| 6H4Q9K546DB     | LAND ROVER   | A2C59513596 |  Diesel common rail piezo injector |
| 6H4Q9K546EB     | LAND ROVER   | A2C59513597 |  Diesel common rail piezo injector |
| 7H2Q9B395CH     | LAND ROVER   | A2C59513482 |  Diesel common rail pump           |
| 7H2Q9K546CB     | FORD         | A2C59513553 |  Diesel common rail piezo injector |



















# Cross Reference List OE No. → Art.-No.

| OE-No./Ref.-No. | Manufacturer | Article-No. | Product name  |
|-----------------|--------------|-------------|---|
| 7T1Q9F593AB     | FORD         | A2C59511611 |  Diesel common rail piezo injector   |
| 8200380253      | RENAULT      | A2C59511606 |  Diesel common rail piezo injector   |
| 8200430599      | RENAULT      | A2C59511605 |  Diesel common rail pump             |
| 8200663258      | RENAULT      | A2C59511605 |  Diesel common rail pump             |
| 8200704200      | RENAULT      | A2C59513595 |  Diesel common rail pump             |
| 8200704200      | DACIA        | A2C59513595 |  Diesel common rail pump             |
| 8200821184      | RENAULT      | A2C59511605 |  Diesel common rail pump             |
| 8200842205      | RENAULT      | A2C59511606 |  Diesel common rail piezo injector   |
| 8200903034      | RENAULT      | A2C59513484 |  Diesel common rail piezo injector   |
| 8200903034      | DACIA        | A2C59513484 |  Diesel common rail piezo injector   |
| 8201041272      | RENAULT      | A2C59507596 |  Diesel common rail piezo injector   |
| 8201041272      | DACIA        | A2C59507596 |  Diesel common rail piezo injector   |
| 9651590880      | PEUGEOT      | 5WS40008-Z  |  Diesel common rail pump             |
| 9652173780      | CITROËN      | 5WS40000-Z  |  Diesel common rail piezo injector |
| 9652173780      | PEUGEOT      | 5WS40000-Z  |  Diesel common rail piezo injector |
| 9655304780      | CITROËN      | 5WS40148-Z  |  Diesel common rail piezo injector |
| 9655304780      | PEUGEOT      | 5WS40148-Z  |  Diesel common rail piezo injector |
| 9655304880      | CITROËN      | 5WS40148-Z  |  Diesel common rail piezo injector |
| 9655304880      | PEUGEOT      | 5WS40148-Z  |  Diesel common rail piezo injector |
| 9657144680      | FIAT         | 5WS40156-4Z |  Diesel common rail piezo injector |
| 9657144880      | FIAT         | A2C59511601 |  Diesel common rail piezo injector |
| 9659337980      | FIAT         | A2C59511602 |  Diesel common rail piezo injector |
| 9663429280      | PEUGEOT      | A2C59511612 |  Diesel common rail piezo injector |
| 9678171880      | CITROËN      | A2C59517045 |  Diesel common rail pump           |
| 9678171880      | PEUGEOT      | A2C59517045 |  Diesel common rail pump           |
| 9681945580      | FIAT         | 5WS40809-Z  |  Diesel common rail pump           |
| 9684704880      | FIAT         | 5WS40809-Z  |  Diesel common rail pump           |
| 9688153080      | CITROËN      | 5WS40809-Z  |  Diesel common rail pump           |
| 9688153080      | PEUGEOT      | 5WS40809-Z  |  Diesel common rail pump           |
| 9801125480      | CITROËN      | A2C59517051 |  Diesel common rail piezo injector |
| 9801125480      | PEUGEOT      | A2C59517051 |  Diesel common rail piezo injector |

| OE-No./Ref.-No. | Manufacturer | Article-No. | Product name  |
|-----------------|--------------|-------------|---|
| 9802448680      | CITROËN      | A2C59513556 |  Diesel common rail piezo injector   |
| 9802448680      | PEUGEOT      | A2C59513556 |  Diesel common rail piezo injector   |
| A2C20000598     | CONTINENTAL  | 5WS40809-Z  |  Diesel common rail pump             |
| A2C20000727     | CONTINENTAL  | 5WS40008-Z  |  Diesel common rail pump             |
| A2C20000754     | CONTINENTAL  | A2C59511605 |  Diesel common rail pump             |
| A2C20003032     | CONTINENTAL  | A2C59511609 |  Diesel common rail pump             |
| A2C20003180     | CONTINENTAL  | A2C59513481 |  Diesel common rail pump             |
| A2C20003282     | CONTINENTAL  | A2C59513482 |  Diesel common rail pump             |
| A2C20003757     | CONTINENTAL  | A2C59511314 |  Diesel common rail pump             |
| A2C27100268     | CONTINENTAL  | A2C59511600 |  Diesel common rail pump             |
| A2C53252602     | CONTINENTAL  | A2C59513595 |  Diesel common rail pump             |
| A2C53341464     | CONTINENTAL  | A2C59517047 |  Diesel common rail pump             |
| A2C53344441     | CONTINENTAL  | A2C59517043 |  Diesel common rail pump             |
| A2C53344443     | CONTINENTAL  | A2C59517045 |  Diesel common rail pump           |
| A2C53351931     | CONTINENTAL  | A2C59507608 |  Diesel common rail pump           |
| A2C53366731     | CONTINENTAL  | A2C59517049 |  Diesel common rail pump           |
| A2C53381555     | CONTINENTAL  | A2C59513830 |  Diesel common rail pump           |
| A2C53381618     | CONTINENTAL  | A2C59507596 |  Diesel common rail piezo injector |
| A2C53384062     | CONTINENTAL  | A2C59513829 |  Diesel common rail pump           |
| LR0008832       | LAND ROVER   | A2C59513596 |  Diesel common rail piezo injector |
| LR0008833       | LAND ROVER   | A2C59513597 |  Diesel common rail piezo injector |
| LR0008834       | LAND ROVER   | A2C59513596 |  Diesel common rail piezo injector |
| LR0008835       | LAND ROVER   | A2C59513597 |  Diesel common rail piezo injector |
| LR002473        | LAND ROVER   | A2C59513596 |  Diesel common rail piezo injector |
| LR002474        | LAND ROVER   | A2C59513597 |  Diesel common rail piezo injector |
| LR002475        | LAND ROVER   | A2C59513596 |  Diesel common rail piezo injector |
| LR002476        | LAND ROVER   | A2C59513597 |  Diesel common rail piezo injector |
| LR005549        | LAND ROVER   | A2C59513482 |  Diesel common rail pump           |
| LR005958        | LAND ROVER   | A2C59511314 |  Diesel common rail pump           |
| LR006495        | LAND ROVER   | A2C59511364 |  Diesel common rail piezo injector |
| LR006496        | LAND ROVER   | A2C59513553 |  Diesel common rail piezo injector |









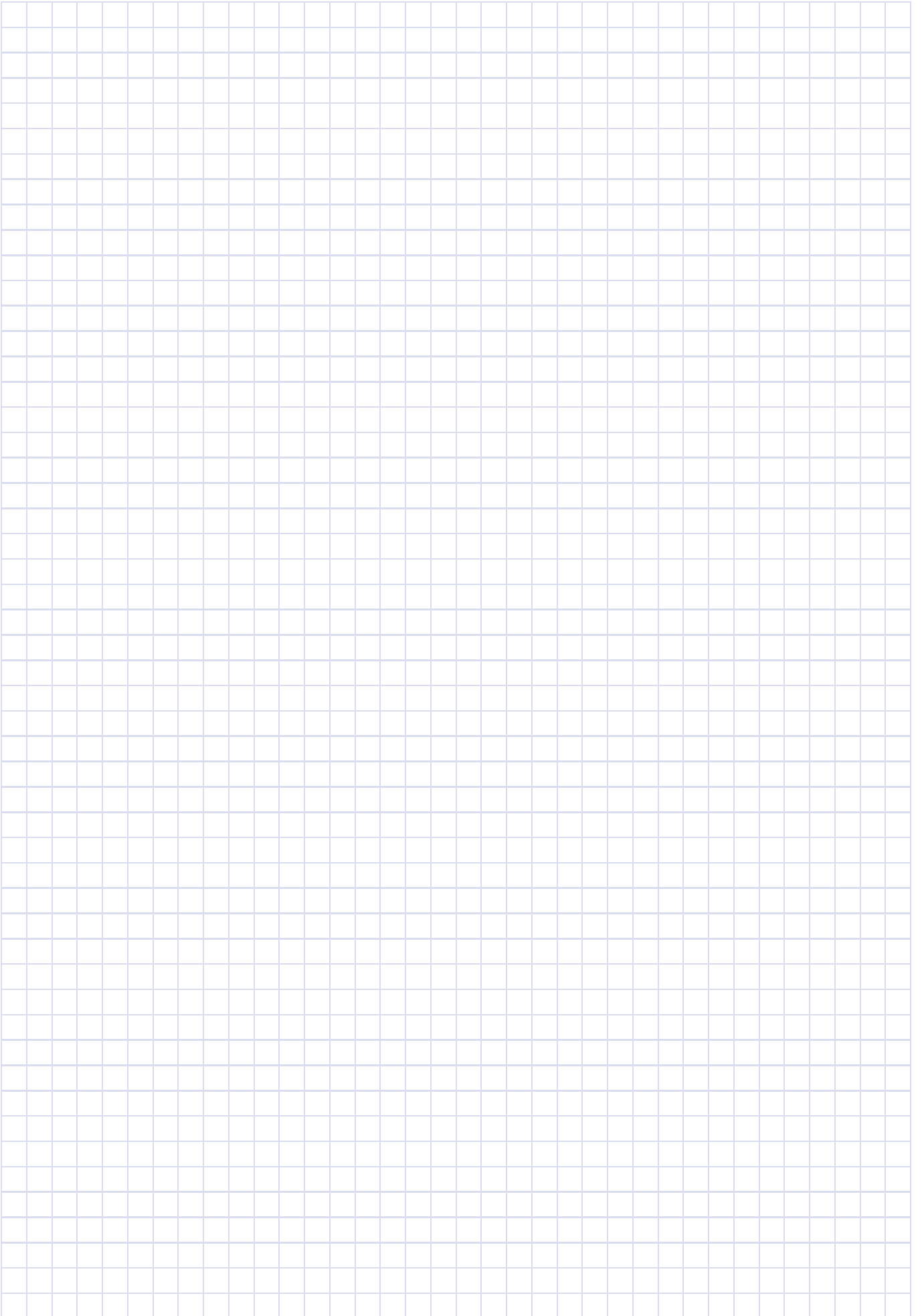

| OE-No./Ref.-No. | Manufacturer | Article-No. | Product name  |
|-----------------|--------------|-------------|---|
| LR006735        | LAND ROVER   | A2C59513481 |  Diesel common rail pump             |
| LR008831        | LAND ROVER   | A2C59513482 |  Diesel common rail pump             |
| LR008836        | LAND ROVER   | A2C59511364 |  Diesel common rail piezo injector   |
| LR008837        | LAND ROVER   | A2C59513553 |  Diesel common rail piezo injector   |
| LR009666        | LAND ROVER   | A2C59513482 |  Diesel common rail pump             |
| LR009737        | LAND ROVER   | A2C59513481 |  Diesel common rail pump             |
| LR009804        | LAND ROVER   | A2C59511314 |  Diesel common rail pump             |
| LR010136        | LAND ROVER   | A2C59513481 |  Diesel common rail pump             |
| LR010189        | LAND ROVER   | A2C59513481 |  Diesel common rail pump             |
| LR017367        | LAND ROVER   | A2C59513482 |  Diesel common rail pump             |
| LR024834        | LAND ROVER   | A2C59511314 |  Diesel common rail pump             |
| LR029969        | LAND ROVER   | A2C59517043 |  Diesel common rail pump             |
| LR032067        | LAND ROVER   | A2C59517051 |  Diesel common rail piezo injector  |
| LR049606        | LAND ROVER   | A2C59513482 |  Diesel common rail pump           |
| LR052872        | LAND ROVER   | A2C59517043 |  Diesel common rail pump           |
| Y401-13-800B    | MAZDA        | 5WS40008-Z  |  Diesel common rail pump           |
| Y404-13-250A    | MAZDA        | A2C59511612 |  Diesel common rail piezo injector |



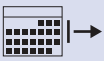

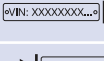
| OE-No./Ref.-No. | Manufacturer | Article-No. | Product name |
|-----------------|--------------|-------------|--------------|
|-----------------|--------------|-------------|--------------|

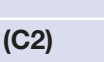

| EN           |  |
|--------------|--|
|              | Construction year from   |
|              | Construction year to   |
|              | Chassis number from  |
|              | Chassis number to  |
|              | Engine Code  |
|              | Fuel Type  |
|              | Diesel common rail piezo injector                                  |
|              | Diesel common rail pump  |
| <b>(C2)</b>  | Version  |
| <b>(C3)</b>  | Specification  |
| <b>(C20)</b> | Model year from  |
| <b>(C21)</b> | Model year to  |
| <b>(C27)</b> | Observe the vehicle manufacturer specifications                    |
| <b>(V65)</b> | Diesel   |
| <b>T019</b>  | Have to be taught/updated.   |
| <b>T024</b>  | Mandatory - check new part against old part (in particular OE No.) |
| <b>T041</b>  | Please note the classification of the injector (4, 5 or 6).        |

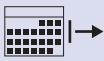
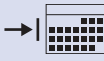
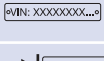
| DE           |   |
|--------------|---|
|              | Baujahr ab  |
|              | Baujahr bis   |
|              | Fahrgestellnummer ab  |
|              | Fahrgestellnummer bis                                       |
|              | Motorcode   |
|              | Kraftstoffart   |
|              | Diesel Common Rail Piezo Injektor                           |
|              | Diesel Common Rail Pumpe                                    |
| <b>(C2)</b>  | Version   |
| <b>(C3)</b>  | Spezifikation   |
| <b>(C20)</b> | Modelljahr ab   |
| <b>(C21)</b> | Modelljahr bis  |
| <b>(C27)</b> | Vorgaben des Fahrzeugherstellers beachten                   |
| <b>(V65)</b> | Diesel  |
| <b>T019</b>  | Muß angelehrt/aktualisiert werden.                          |
| <b>T024</b>  | Zwingend Alt- mit Neuteil abgleichen (insbesondere OE-Nr.)  |
| <b>T041</b>  | Bitte Klassifizierung des Injektors beachten (4, 5 oder 6). |

| FR  |   |
|---|---|
|  | Année à partir de   |
|  | Année jusqu'à   |
|  | N° de châssis à partir de   |
|  | N° de châssis jusqu'à   |
|  | Code moteur   |
|  | Type de carburant   |
|  | Injecteur piézoélectriques diesel common rail   |
|  | Pompe diesel common rail  |
| <b>(C2)</b>   | Version   |
| <b>(C3)</b>   | Spécification   |
| <b>(C20)</b>  | Année à partir de   |
| <b>(C21)</b>  | Année jusqu'à   |
| <b>(C27)</b>  | Attention aux indications du constructeurs du véhicule  |
| <b>(V65)</b>  | Diesel  |
| <b>T019</b>   | Doit être adapté/ actualisé.  |
| <b>T024</b>   | Vérifier impérativement que l'ancienne pièce et la neuve sont identiques (en particulier n° OE) |
| <b>T041</b>   | Merci de tenir compte de la classification de l'injecteur (4, 5 ou 6).                          |

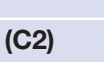
| ES  |  |
|---|--|
|  | año construcción desde   |
|  | año construcción hasta   |
|  | n° de chasis desde   |
|  | n° de chasis hasta   |
|  | Código de motor  |
|  | Tipo de combustible  |
|  | Inyectore diésel piezo para sistemas Common Rail   |
|  | Bomba diésel para sistemas Common Rail   |
| <b>(C2)</b>   | Versión  |
| <b>(C3)</b>   | Especificación   |
| <b>(C20)</b>  | año modelo desde   |
| <b>(C21)</b>  | año modelo hasta   |
| <b>(C27)</b>  | Observar las indicaciones del constructor  |
| <b>(V65)</b>  | Gasóleo  |
| <b>T019</b>   | En caso deberá instruirse/actualizarse.  |
| <b>T024</b>   | Es obligatorio comparar la pieza vieja con la nueva (en particular el n.º de equipamiento original (OE)) |
| <b>T041</b>   | Rogamos que tengan en cuenta la clasificación del inyector (4, 5 o 6).                                   |

| IT           |   |
|--------------|---|
|              | Anno da   |
|              | Anno fino a   |
|              | N° telaio da  |
|              | N° telaio fino a  |
|              | Codice motore   |
|              | Tipo carburante   |
|              | Iniettor diesel common rail piezo-elettrici   |
|              | Pompe diesel common rail  |
| <b>(C2)</b>  | Versione  |
| <b>(C3)</b>  | Specificazione  |
| <b>(C20)</b> | Anno modello da   |
| <b>(C21)</b> | Anno modello fino a   |
| <b>(C27)</b> | Osservare direttive costruttore veicolo   |
| <b>(V65)</b> | Diesel  |
| <b>T019</b>  | Necessita di un training/aggiornamento.   |
| <b>T024</b>  | È obbligatorio comparare il pezzo vecchio con quello nuovo (in particolare il no. OE) |
| <b>T041</b>  | Si prega di osservare la classifica dell'iniettore (4, 5 o 6).                        |

| RU           |   |
|--------------|---|
|              | Год выпуска с   |
|              | Год выпуска до  |
|              | Номер шасси с   |
|              | Номер шасси до  |
|              | Код двигателя   |
|              | Вид топлива   |
|              | Форсунки Piezo для систем впрыска с общим нагнетательным трубопроводом типа Common Rail |
|              | Насосы для систем впрыска с общим нагнетательным трубопроводом типа Common Rail         |
| <b>(C2)</b>  | Версия  |
| <b>(C3)</b>  | Спецификация  |
| <b>(C20)</b> | Модельный год от  |
| <b>(C21)</b> | Модельный год до  |
| <b>(C27)</b> | Обратить внимание на заданные величины производителя трансп.                            |
| <b>(V65)</b> | дизельное топливо   |
| <b>T019</b>  | Необходимо обучение/актуализация.   |
| <b>T024</b>  | Обязательно сравнивать старую и новую детали (в частности, номер OE)                    |
| <b>T041</b>  |   |

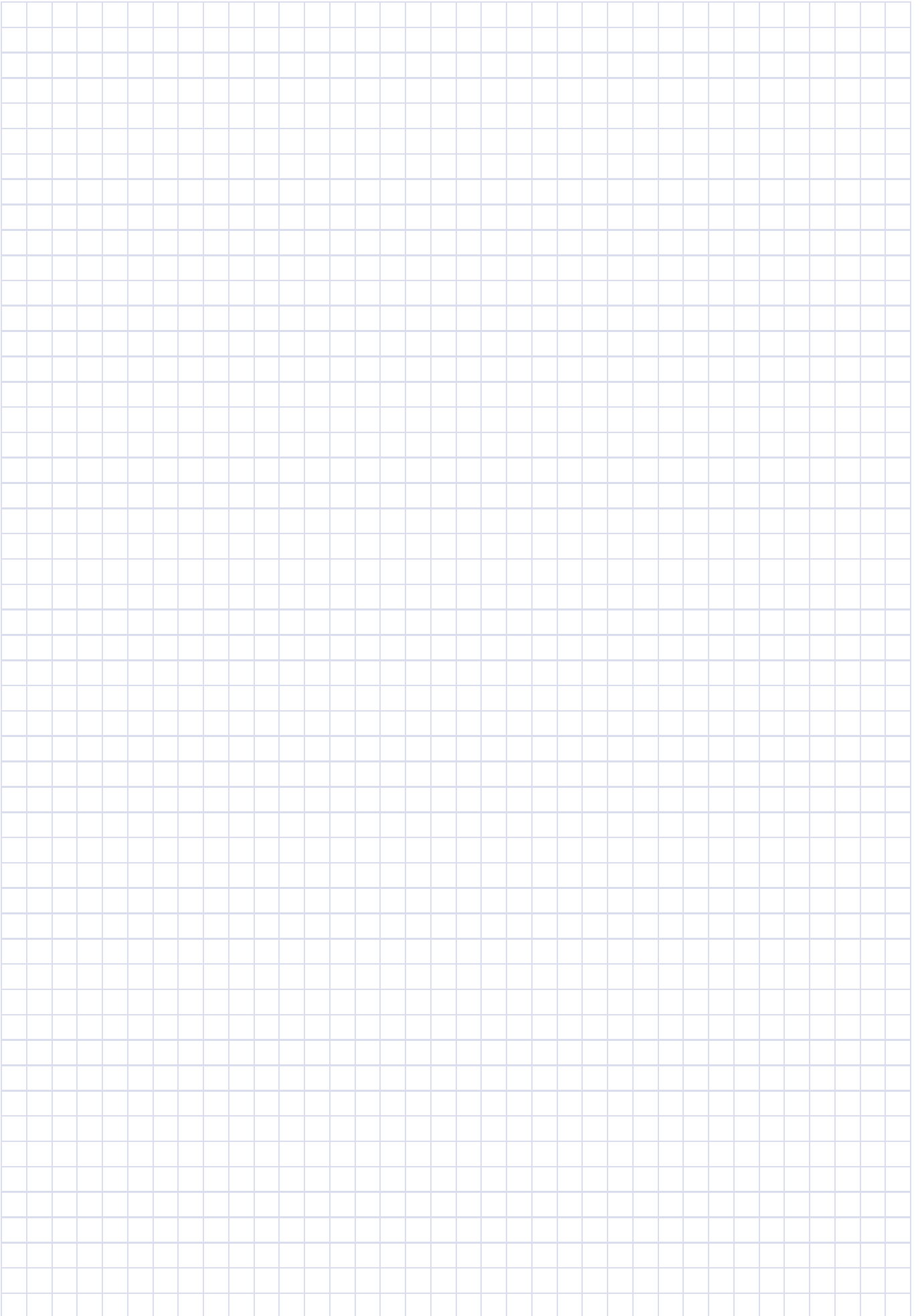



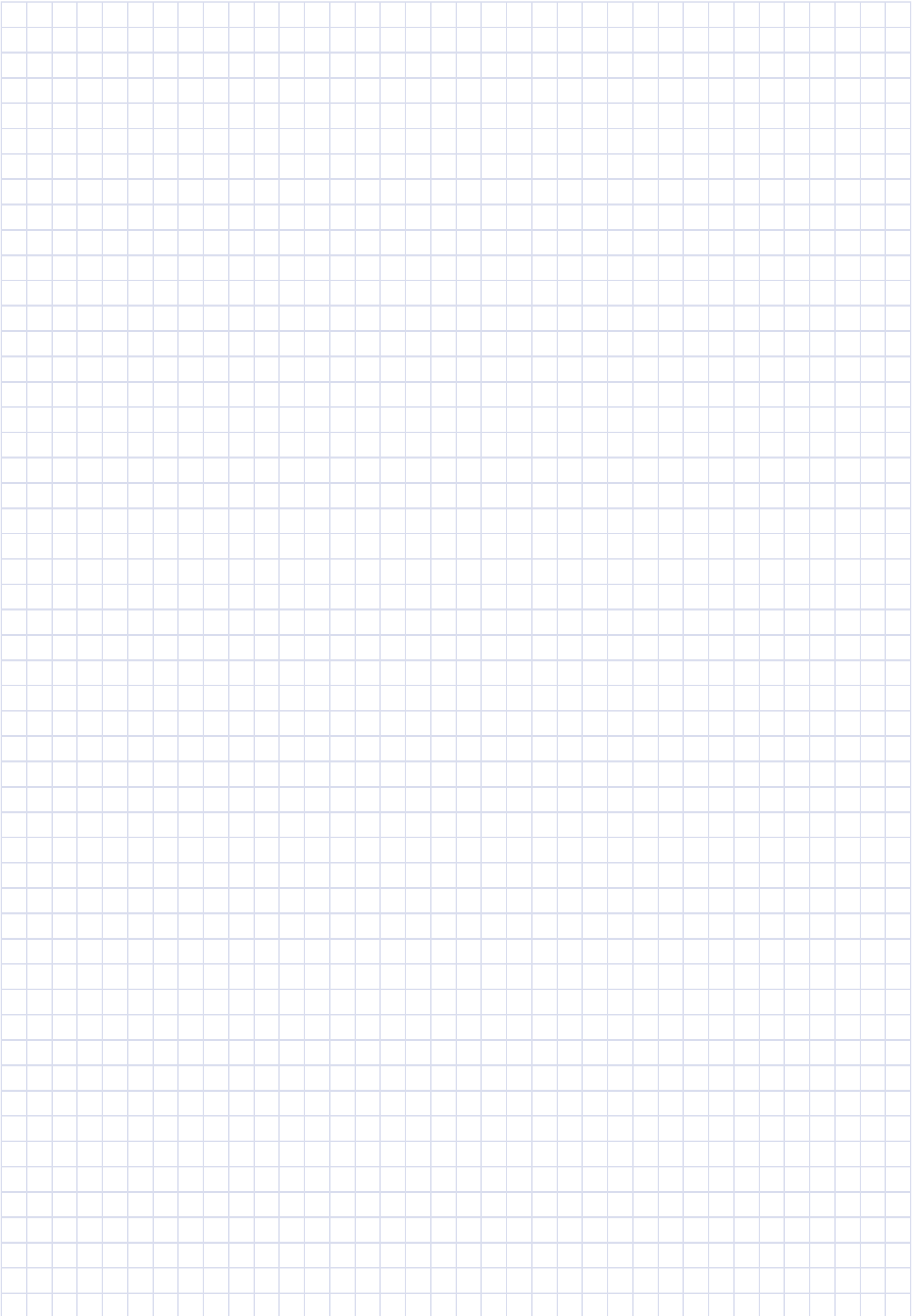





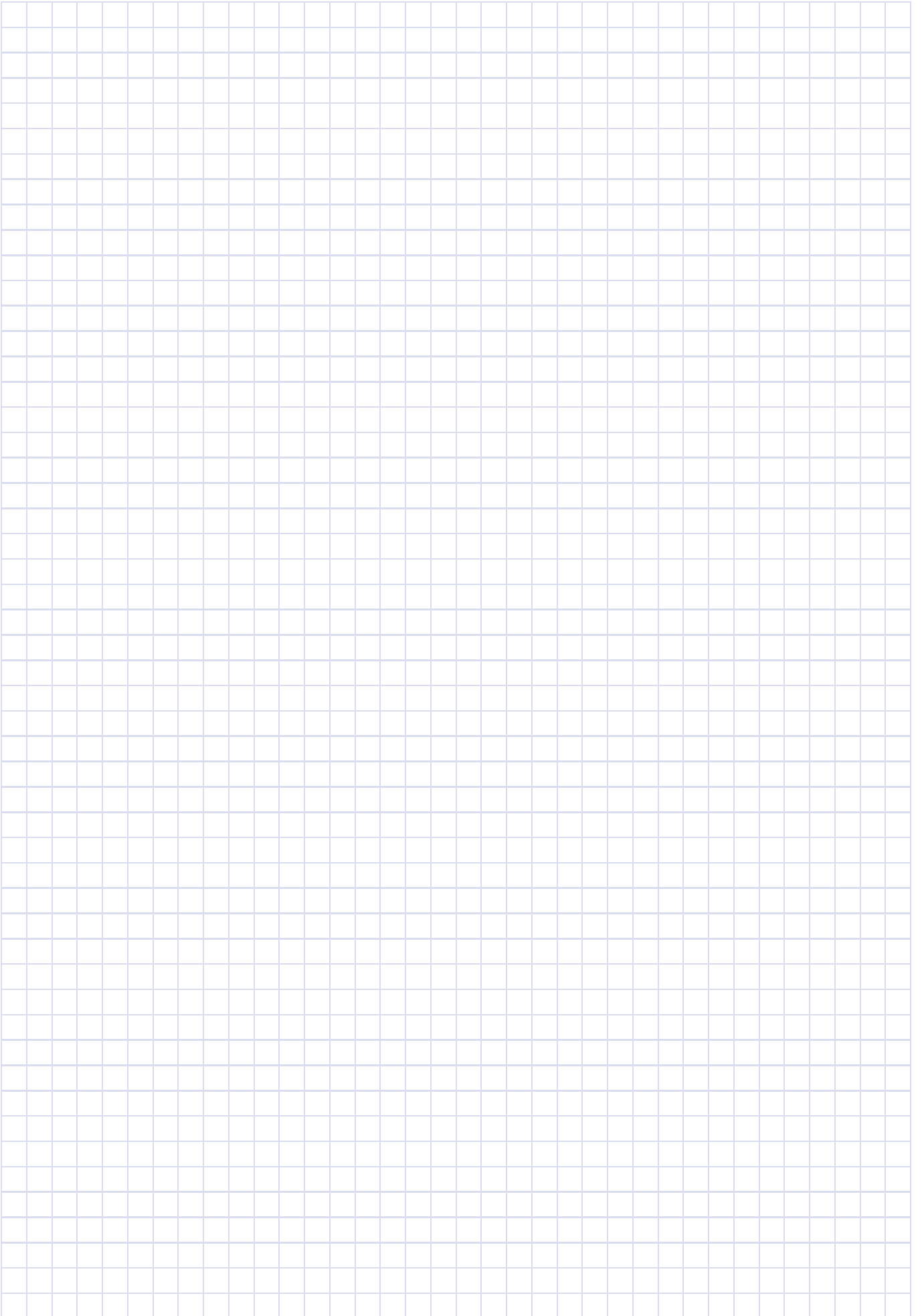

# VDO Replacement Parts

- 1 Engine actuators
- 2 Fuel systems
- 3 Sensors for engine management
- 4 Sensors for instrumentation
- 5 Sensors for tire pressure monitoring systems (TPMS)
- 6 HVAC blower and fan systems
- 7 Screen and headlight washer systems
- 8 Actuators for central locking systems
- 9 Diagnostic systems
- 10 Common Rail Diesel
- 11 Battery

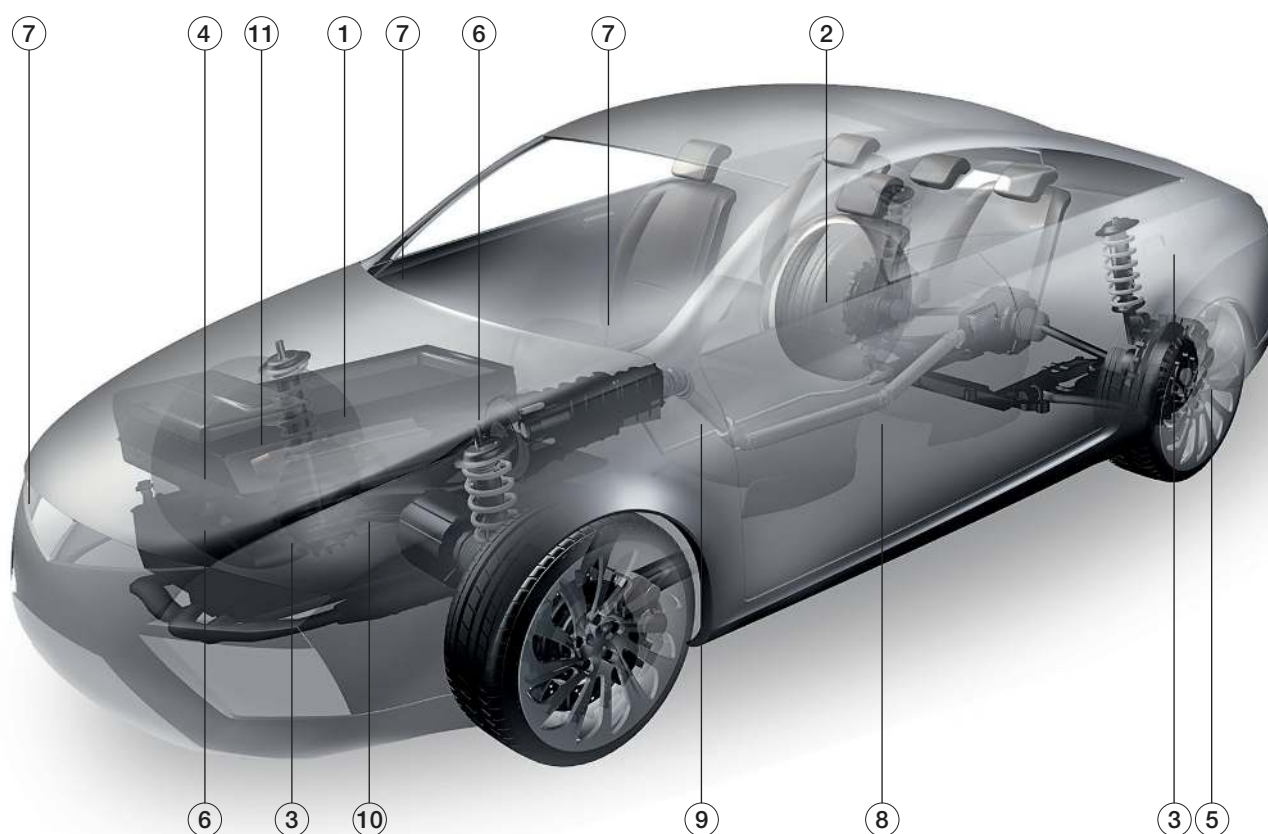

## Online Catalog

Please consult our easy-to-use catalogs for detailed, up to date information about the replacement parts available or visit our website at: [www.vdo.com](http://www.vdo.com)



Continental is a certified TecDoc partner.



**Continental Trading GmbH**

Sodener Strasse 9

D-65824 Schwalbach

Germany

Tel: + 49 6196 87-0

Fax: + 49 6196 86571

[www.vdo.com](http://www.vdo.com)

E-Mail: [replacementparts@vdo.com](mailto:replacementparts@vdo.com)

VDO - A Trademark of the Continental Corporation

The information provided in this brochure contains only general descriptions or performance characteristics, which do not always apply as described in case of actual use or which may change as a result of further development of the products. This information is merely a technical description of the product. This information is not meant or intended to be a special guarantee for a particular quality or a particular durability. An obligation to provide the respective characteristics shall only exist if expressly agreed in the terms of contract. We reserve the right to make changes in availability as well as technical changes without prior notice.

Please note: Application – The products described in this catalogue are designed for use in land vehicles, engines and equipment. Disclaimer – The data in this replacement parts catalogue has been compiled and processed for the purpose of presenting our replacement parts range and is correct to the best of our knowledge. Subject to technical alterations, errors and omissions. Availability is not guaranteed. We cannot be held liable with regard to any information contained in the Continental Trading replacement parts catalogue except in case of intent, gross negligence or where mandatory liability is borne in accordance with German product liability law.

© Continental Trading GmbH 05/2016  
Printed in Germany

**VDO**